

Form 18274
December, 1928
PRINTED IN U. S. A.

LIST OF PARTS



MACHINES

Nos. 147-24 and 147-26

THE SINGER MANUFACTURING COMPANY

COPYRIGHT, U. S. A., 1925 AND 1928,
BY THE SINGER MANUFACTURING Co.
ALL RIGHTS RESERVED FOR ALL COUNTRIES

INDEX

	PAGE
ACCESSORIES.....	26
BENCH STAND.....	28
FOOT LIFTER PARTS.....	27
KNEE LIFTER PARTS.....	27
MACHINE No. 147-24.....	7
" No. 147-26.....	18
" BASE WITH BELT GUARD.....	26
NUMERICAL LIST OF PARTS.....	31
THREAD UNWINDER FOR 147-24 MACHINE.....	28
" " " 147-26 MACHINE.....	29

From the library of: Diamond Needle Corp

INSTRUCTIONS FOR ORDERING

In ordering from this list, use **ONLY** the part NUMBER in the **FIRST** column.

The number stamped on a Sewing Machine part is in every case the number of the single part only.

Every combination of parts sent out as such has its specific number, which, although not stamped on the parts, must be used when ordering the combination.

Each number always indicates the **SAME PART** in whatever list it appears, or for whatever machine.

The letters after some of the numbers indicate the style of finish only, as follows:

- A—Hardened, Polished, Nickel Plated and Buffed
- B—Polished, Nickel Plated and Buffed
- C—Hardened Only
- D—Polished Only
- E—Soft, Not Polished
- F—Hardened and Polished
- H—Blued
- J—Nickel Plated Only
- K—Hardened and Nickel Plated
- L—Brass Plated
- M—Oxidized
- P—Japanned
- R—Merlized
- T—Copper Plated
- T. A.—Hardened, Polished, Copper and Nickel Plated and Buffed.
- T. B.—Copper and Nickel Plated and Polished.
- T. J.—Copper and Nickel Plated Only.
- T. K.—Hardened, Copper and Nickel Plated.
- T. M.—Copper Plated and Oxidized.
- T. L.—Copper and Brass Plated.
- U—Zinc Plated
- V—Silver Plated
- W—Polished and Nickel Plated
- Z—Chromium Plated

These letters **MUST BE USED** when they appear in the list; and **AFTER** the number **as** in the list.

In this series:

- 1 to 1500 and 50001 to 51500 are Screw Numbers.
- 1501 to 1800 and 51501 to 51800 are Nut Numbers.
- 1801 to 2000 and 51801 to 52000 are Roller Numbers.
- 2001 to 50000 and 52001 and upward are numbers of Machine Parts.

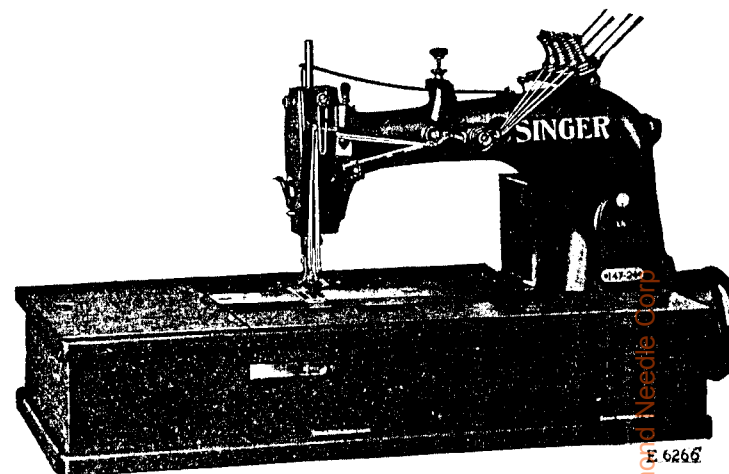
The figures in the second column refer only to the plates, illustrating the parts, and are **NOT TO BE USED** in ordering.

Parts marked with an asterisk (*) are furnished only when repairs are made at factory.

When ordering parts which differ as to **Gauge** (the distance between seams) the Gauge, as well as the **Number must be given** on order.

LIST OF PARTS COMPLETE

FOR



MACHINE No. 147-24

FOR FOUR LINE SHOE TIPPING; ALSO FOR EYELET ROW STITCHING. FOUR NEEDLES, TWO LOOPERS. BY REMOVING ONE OR MORE NEEDLES, TWO OR THREE LINE STITCHING CAN BE OBTAINED. GAUGES BETWEEN THE FIRST AND SECOND AND BETWEEN THE THIRD AND FOURTH NEEDLES $\frac{1}{32}$ TO $\frac{5}{64}$ INCH AND BETWEEN THE SECOND AND THIRD NEEDLES $\frac{1}{8}$ TO $\frac{1}{16}$ INCH. SPEED UP TO 3200.

NO.	PLATE	NAME
*54182	—	Arm, upper and lower (solid) with 9480 and 54034.....
42366	8901	Arm Oil Pad (braided cotton) for oiling Arm Rock Shaft Front Bearing.....
56006	8901	Arm Oil Pad (braided cotton) for oiling Arm Rock Shaft Intermediate Bearing.....
56003	8985	Arm Oil Tube with 29599, for oiling 54326
29599	8901	" " " Packing (felt).....
54183	8987	" Rock Shaft.....
54192	—	" " " 54183 with 46383, 54004, 54184 and 64255.....
64386	8901	Arm Rock Shaft Bushing (back).....

NO.	PLATE	NAME
446c	8901	Arm Rock Shaft Bushing (back) Set Screw
64388	8901	" " " " (intermediate)
423c	8901	" " " " " "
		Set Screw.....
52045	8901	Arm Rock Shaft Bushing Oil Pad (braided cotton).....
54004	8901	Arm Rock Shaft Collar with two 453c....
453c	8901	" " " " Set Screw.....
54184	8985	" " " Crank (back) with two 50083c.....
50083c	8901	Arm Rock Shaft Crank (back) Set Screw..
64255	8911	" " " " (front) with 453c
2117	8901	" " " " " Pin.....
453c	8901	" " " " " Set Screw..
54105	8901	" " " Flanged Bushing (front)
52045	8901	" " " " " " "
		Oil Pad (braided cotton).....
453c	8901	Arm Rock Shaft Flanged Bushing (front) Set Screw.....
54006	8987	Arm Rotary Shaft.....
54448	—	" " " 54006 with 6406, 54008, 54088, 54113, 54447, 64351 and 64355..
54367	8985	Arm Rotary Shaft Bushing (front).....
761E	8901	" " " " " Set Screw
54007	8902	" " " " (intermediate)
54089	—	" " " " " "
		54007 with 64508 and 64805.....
64508	8902	Arm Rotary Shaft Bushing (intermediate) Oil Pad, long (braided cotton).....
64805	8985	Arm Rotary Shaft Bushing (intermediate) Oil Pad, short (braided cotton).....
422c	8901	Arm Rotary Shaft Bushing (intermediate) Set Screw (long).....
50084c	8901	Arm Rotary Shaft Bushing (intermediate) Set Screw (short).....
54008	8901	Arm Rotary Shaft Collar with two 1258c
1258c	8901	" " " " " Set Screw.....
54009	8902	" " " Flanged Bushing.....
54090	—	" " " " " 54009 with 58039 and 64805.....
58039	8902	Arm Rotary Shaft Flanged Bushing Oil Pad, long (braided cotton).....
64805	8985	Arm Rotary Shaft Flanged Bushing Oil Pad, short (braided cotton).....
159F	8901	Arm Rotary Shaft Flanged Bushing Screw
49013	8904	" " " Front Bearing Oil Pad (braided cotton).....

NO.	PLATE	NAME
144D	8901	Arm Rotary Shaft Screw.....
15196	8902	" Side Cover (back).....
286D	8904	" " " " Thumb Screw....
54010	8904	" " " (front).....
286D	8904	" " " " Thumb Screw...
46220	8986	Balance Wheel, 2 $\frac{1}{8}$ in. pulley, with two 430c.....
430c	8904	Balance Wheel Set Screw.....
54296	8987	Cloth Plate.....
54012	8902	" " Slide (left).....
38419	8904	" " " " Spring.....
725J	8904	" " " " " Screw....
54013	—	Cloth Plate Slide (left) complete, Nos. 38419, 54012 and two 725J.....
54297	8986	Cloth Plate Slide (right) for 54298.....
54299	8986	" " " " " 54300.....
38419	8904	" " " " Spring.....
725J	8904	" " " " " Screw..
54298	—	Cloth Plate Slide (right) complete for 54301, Nos. 38419, 54297 and two 725J
54300	—	Cloth Plate Slide (right) complete for 54302, Nos. 38419, 54299 and two 725J
54301	—	Cloth Plate complete, for $\frac{1}{2}$ in. to $\frac{3}{4}$ in., $\frac{3}{16}$ in. to $\frac{1}{2}$ in. and $\frac{1}{2}$ in. to $\frac{3}{4}$ in. gauges, Nos. 54013, 54296 and 54298.....
54302	—	Cloth Plate complete, for $\frac{1}{2}$ in. to $\frac{3}{4}$ in., $\frac{3}{8}$ in. to $\frac{1}{2}$ in. and $\frac{1}{2}$ in. to $\frac{3}{4}$ in. gauges, Nos. 54013, 54296 and 54300.....
1011F	8904	Cloth Plate Screw (left).....
50473F	8904	" " " (right).....
54104	8913	" " Thread Guard.....
1235D	8904	" " " " Screw.....
54017	8902	Crank Connecting Rod with 6575, 54018, 54218, 54897, 57222 and two each 896E and 1057E.....
54088	—	Crank Connecting Rod 54017 with 50069c
50069c	8904	" " " Ball Screw Stud
1516E	8904	" " " " " " "
		Nut.....
64268	8904	Crank Connecting Rod Ball Screw Stud Washer.....
*57222	—	Crank Connecting Rod Cap (lower).....
896E	8904	" " " " " Screw
*54018	—	" " " " (upper).....
1057E	8904	" " " " " Screw
54897	8904	" " " " Oil Cup.....

From the Library of the American Museum of Natural History

NO.	PLATE	NAME
54218	8904	Crank Connecting Rod Oil Pad (braided cotton).....
6575	8904	Crank Connecting Rod Oil Pad Stop Pin
64269	8913	Face Plate.....
46111	8911	" " Pin.....
286D	8904	" " Thumb Screw.....
54019	8902	Feed Bar with 50429c and two 453c.....
54020	8902	" " Connection.....
57225	8904	" " Hinge Pin.....
453c	8901	" " " " Set Screw.....
54111	8902	" Connecting Rod with 1057E, 54112 and two 896E.....
54113	—	Feed Connecting Rod 54111 with 54025..
*54112	—	" " " Cap.....
896E	8904	" " " " Screw.....
1057E	8904	" " " Clamping Screw..
54023	8911	" " " Hinge Pin.....
21506	8904	" " " " Collar with 457c.....
457c	8904	Feed Connecting Rod Hinge Pin Collar Set Screw.....
46373	6560	Feed Dog, 18 teeth (16 teeth to the inch) for $\frac{1}{2}$ in. to $\frac{3}{4}$ in., $\frac{3}{16}$ in. to $\frac{7}{32}$ in. and $\frac{1}{32}$ in. to $\frac{3}{4}$ in. gauges.....
46374	6560	Feed Dog, 18 teeth (16 teeth to the inch) for $\frac{1}{2}$ in. to $\frac{3}{4}$ in., $\frac{1}{4}$ in. to $\frac{3}{32}$ in. and $\frac{1}{32}$ in. to $\frac{3}{4}$ in. gauges.....
46459	6560	Feed Dog, 18 teeth (16 teeth to the inch) for $\frac{1}{2}$ in. to $\frac{5}{8}$ in., $\frac{1}{8}$ in. to $\frac{5}{32}$ in. and $\frac{1}{32}$ in. to $\frac{5}{8}$ in. gauges.....
53197	8988	Feed Dog, 18 teeth (16 teeth to the inch) for $\frac{1}{2}$ in. to $\frac{5}{8}$ in., $\frac{9}{32}$ in. to $\frac{13}{32}$ in. and $\frac{1}{32}$ in. to $\frac{5}{8}$ in. gauges.....
157D	8904	Feed Dog Screw.....
50429c	8904	" " Stop Screw.....
*54024	—	" Eccentric.....
*23729	—	" " Body.....
51061c	8958	" " " Set Screw.....
7071	8904	" " Clamping Washer.....
217D	8904	" " " " Screw..
54025	8985	Feed Eccentric (adjustable) complete, Nos. 217D, 1103c, 7071, 23729, 54024 and two 51061c.....
1103c	8904	Feed Regulating Screw.....
54026	8905	" Rocking Frame with two 453c.....
54077	—	" " " 54026 with 21506, 54019, 54020, 54023 and 57225.....

NO.	PLATE	NAME
57234	8911	Feed Rocking Frame Hinge Pin.....
57235	8985	" " " " " Bushing
453c	8901	" " " " " " Set Screw.....
453c	8901	Feed Rocking Frame Hinge Pin Set Screw
54370	8989	Looper (back) with 590D and 46115.....
1147c	8989	" " Set Screw.....
54371	8989	" (front).....

NOTE: When ordering No. 54370 or 54371, state gauge of machine for which required

54372	—	Looper (front) 54371 with 46377 and two 229D.....
46377	8989	Looper (front) Needle Guard with 46105..
46105	8989	" " " " Pin.....
229D	8958	" " " " Screw.....
1120c	8958	" " Set Screw.....
54027	8989	" Carrier with two 171D.....
171D	8958	" " Adjusting Screw.....
54227	8989	" " Connection.....
54228	8989	" " " Shaft.....
54229	8989	" " " " Bushing
446c	8901	" " " " " " Set Screw.....
49013	8901	Looper Carrier Connection Shaft Oil Pad (braided cotton).....
54230	8989	Looper Carrier Driver with 54032 and four 175E.....
*54032	—	Looper Carrier Driver Cap.....
175E	8958	" " " " Screw.....
54440	8990	" Driving Shaft and Feed Lifting Eccentric with 227D and two 64315..
54447	—	Looper Driving Shaft and Feed Lifting Eccentric 54440 with 54027, 54227, 54228 and 54230.....
*54034	8905	Looper Driving Shaft and Feed Lifting Eccentric Bracket with 761E.....
54080	8990	Looper Driving Shaft and Feed Lifting Eccentric Bracket Bushing.....
761E	8901	Looper Driving Shaft and Feed Lifting Eccentric Bracket Bushing Set Screw..
948D	8958	Looper Driving Shaft and Feed Lifting Eccentric Bracket Screw.....
64315	8990	Looper Driving Shaft and Feed Lifting Eccentric Oil Hole Plug.....
227D	8958	Looper Driving Shaft and Feed Lifting Eccentric Oil Hole Screw.....

NO.	PLATE	NAME
40326	8990	Looper Driving Shaft and Feed Lifting Eccentric Oil Pad (braided cotton)....
640D	8958	Looper Driving Shaft and Feed Lifting Eccentric Screw.....
54061	8990	Looper Holder with 1120c and 1147c....
704J	8958	" " Screw.....
46115	8989	" Thread Guard (double).....
590D	8958	" " " Screw.....
64319	8991	Needle Bar (hollow).....
54238	—	Needle Bar complete, Nos. 46122 and 64319.....
38456	8991	Needle Bar Bushing (lower).....
1133E	8958	" " " " Set Screw....
64320	8991	" " " (upper).....
1133E	8958	" " " " Set Screw....
54326	8991	" " Connecting Link.....
54329	—	" " " " 54326 with 54327 and 54328.....
54327	8991	Needle Bar Connecting Link Hinge Stud
1520E	8991	" " " " " " Nut.....
54328	8991	Needle Bar Connecting Stud with 211F and two 187E.....
187E	8958	Needle Bar Connecting Stud Clamping Screw.....
46118	8991	Needle Clamp Body.....
46119	8991	" " Collar with 46120 and three 457E.....
457F	8904	Needle Clamp Collar Set Screw.....
46120	8991	" " Thread Guard.....
46121	8991	" " Washer.....
46122	—	Needle Clamp complete, Nos. 46118, 46119 and 46121.....
54239	8995	Needle Guard, for gauges $\frac{3}{8}$ in. to $\frac{1}{2}$ in. between the second and third needles..
54335	8995	Needle Guard, for gauges $\frac{1}{8}$ in. to $\frac{1}{4}$ in. between the second and third needles..
54336	8995	Needle Guard, for gauges $\frac{3}{8}$ in. to $\frac{1}{2}$ in. between the second and third needles..
54038	8991	Needle Guard Holder.....
176D	8958	" " " Screw.....
219D	8991	" " Screw.....
457F	8904	" Set Screw.....
54188	8991	Oil Cup.....
1284D	8991	" " Regulating Screw.....
2026	8991	" " " " Spring.....
38100	8991	" " Packing (felt).....

NO.	PLATE	NAME
54189	—	Oil Cup complete, for oiling upper thread, Nos. 1284D, 2026, 38100 and 54188....
1423J	8991	Oil Cup Screw.....
54108	—	" Tube.....
54109	—	" " Bracket.....
49092	8990	" " Packing (felt).....
54110	8990	Oil Tube complete, for oiling crank connecting rod (upper bearing) Nos. 49092, 54108 and 54109.....
64330	8986	Presser Bar with 25303.....
25303	8990	" " Ball, size $\frac{1}{4}$ in.....
54325	8985	" " Bushing (lower).....
1133E	8958	" " " " Set Screw....
38456	8991	" " " (upper).....
1133E	8958	" " " " Set Screw....
54039	8985	" " Guide Bracket with 453c, 640J and 1963.....
640J	8958	Presser Bar Guide Bracket Adjusting Screw.....
11173	8985	Presser Bar Guide Bracket Guide.....
447c	8958	" " " " " Set Screw
1963	8985	" " " " Roller and Stud.....
453c	8901	Presser Bar Guide Bracket Set Screw....
57257	8911	" " Lifter.....
57258	8911	" " " Hinge Pin.....
447c	8958	" " " " " Set Screw..
1872	8985	" " " Roller and Stud.....
1250c	8911	" " " Stop Screw.....
61047	8911	" " Lifting Bracket with 460c and 1872.....
64362	8996	Presser Bar Lifting Lever.....
61075	8911	" " " " Connecting Stud.....
460c	8993	Presser Bar Lifting Lever Connecting Stud Set Screw.....
54103	8905	Presser Bar Lifting Lever Extension....
161D	8958	" " " " " Screw (left).....
176D	8958	Presser Bar Lifting Lever Extension Screw (right).....
802D	8958	Presser Bar Lifting Lever Hinge Screw..
54040	8905	" " Spring (flat).....
38468	8990	" " " Stud.....
46173	6561	" Foot (left guide) with 337D and 46174.....
46174	6561	Presser Foot Guide (left) for 46173.....

From the library of: Darabot Needle Shop

NO.	PLATE	NAME
337D	6561	Presser Foot Guide (left) Screw.....
46126	6561	" " (right guide) with 337D and 46127.....
46127	6561	Presser Foot Guide (right) for 46126....
337D	6561	" " " " Screw.....
46296	6561	" " " (left) for 46299.....
337D	6561	" " " Screw (back).....
665D	6561	" " " " (front).....
26276	8911	" " Hinge Pin.....
46297	—	" " Plate.....
46298	—	" " Shank.....
46299	6561	Presser Foot (side hinged) with left guide, complete, Nos. 337D, 665D, 26276 and 46296 to 46298.....
46300	6561	Presser Foot Guide (right) for 46303....
337D	6561	" " " Screw (back).....
665D	6561	" " " " (front).....
26276	8911	" " Hinge Pin.....
46301	—	" " Plate.....
46302	—	" " Shank.....
46303	6561	Presser Foot (side hinged) with right guide, complete, Nos. 337D, 665D, 26276 and 46300 to 46302.....
190D	8958	Presser Foot Screw.....
574J	8958	Pressure Regulating Thumb Screw.....
1539J	8992	" " " " Lock Nut.....
54241	8990	Slack Thread Controller.....
54242	8990	" " " Clamp.....
190D	8958	" " " " Screw....
54243	8990	" " Regulator.....
54042	8990	" " " Holder with 175E and 50150c.....
175E	8958	Slack Thread Regulator Holder Clamping Screw.....
54043	8990	Slack Thread Regulator Holder Shaft
24292	8990	" " " " " " Collar with 1019c.....
1019c	8958	Slack Thread Regulator Holder Shaft Collar Set Screw.....
54044	8990	Slack Thread Regulator Holder Shaft Crank (forked) with 1253c.....
1253c	8958	Slack Thread Regulator Holder Shaft Crank Set Screw.....
50150c	8958	Slack Thread Regulator Set Screw.....
2102	8964	Tension (under thread) Disc.....

NO.	PLATE	NAME
51570c	8964	Tension (under thread) Regulating Thumb Nut.....
50326c	8964	Tension (under thread) Screw Stud.....
59539	—	" " " " " 50326c with 51570c.....
59534	8964	Tension (under thread) Spring.....
59537	8964	" " " " Bushing (large).....
59538	8964	Tension (under thread) Spring Bushing (small).....
17547	8964	Tension (under thread) Thread Guide....
54216	8992	" (upper thread, automatic) Body
1508J	8992	" " " " " Nut.....
54333	8992	Tension (upper thread, automatic) Body Releasing Pin.....
46383	8992	Tension (upper thread, automatic) Cam with two 1253c.....
1253c	8958	Tension (upper thread, automatic) Cam Set Screw.....
2102	8964	Tension (upper thread, automatic) Disc..
1560c	8992	" " " " " Regu- lating Thumb Nut.....
32572	8964	Tension (upper thread, automatic) Releas- ing Disc.....
50106c	8992	Tension (upper thread, automatic) Screw Stud.....
53213	—	Tension (upper thread, automatic) Screw Stud 50106c with 1560c.....
46385	8992	Tension (upper thread, automatic) Screw Stud Releasing Pin.....
46387	8992	Tension (upper thread, automatic) Spring
54244	8992	" " " " " Thread Guide.....
54245	8996	Tension (upper thread) Bracket.....
376D	8958	" " " " " Screw...
2102	8964	" " " " " Disc.....
51570c	8964	" " " " " Regulating Thumb Nut.....
32572	8964	Tension (upper thread) Releasing Disc....
54988	8964	" " " " " Pin.....
54246	8992	" " " " " S h a f t
54047	8964	" " " " " " Crank with 624c.....
54048	8964	Tension (upper thread) Releasing Shaft Crank Link.....

NO.	PLATE	NAME
624c	8958	Tension (upper thread) Releasing Shaft Crank Set Screw.....
54990	8964	Tension (upper thread) Releasing Shaft Spring.....
316f	8958	Tension (upper thread) Releasing Shaft Stop Screw.....
1547j	8992	Tension (upper thread) Releasing Shaft Stop Screw Nut.....
50326c	8964	Tension (upper thread) Screw Stud.....
59539	—	“ “ “ “ “ 50326c with 51570c.....
59535	8964	Tension (upper thread) Spring.....
59537	8964	“ “ “ “ Bushing (large).....
59538	8964	Tension (upper thread) Spring Bushing (small).....
57076	8964	Tension (upper thread) Thread Guide (double).....
53225	8993	Thread (under) Eyelet (back).....
190d	8958	“ “ “ “ Screw.....
54072	8993	“ “ “ (front).....
64351	8994	“ “ Nipper Cam with 465c....
465c	8958	“ “ “ “ Set Screw....
38210	8993	“ “ “ Spring (lower)....
38211	8993	“ “ “ “ (upper)....
46247	8993	“ “ “ “ Stop
176d	8958	“ “ “ “ Screw.....
54441	8995	“ “ Take-up with 465c.....
465c	8958	“ “ “ Set Screw.....
54341	8993	“ “ “ Staple with 38481, 54342 and two 590d.....
54049	8905	Thread (under) Take-up Staple Bracket with 460c.....
965d	8993	Thread (under) Take-up Staple Bracket Screw.....
46041	8993	Thread (under) Take-up Staple Spring....
190d	8958	“ “ “ “ Screw
54342	8993	“ “ “ “ Thread Guard (left).....
590d	8958	Thread (under) Take-up Staple Thread Guard (left) Screw.....
38481	8994	Thread (under) Take-up Staple Thread Guard (right).....
590d	8958	Thread (under) Take-up Staple Thread Guard (right) Screw.....

NO.	PLATE	NAME
38482	8993	Thread (under) Take-up Stripper.....
207d	8993	“ “ “ “ Screw..
64355	8994	“ “ “ Thread Guard (brass).....
64356	8993	Thread (under) Take-up Thread Guard Steady Pin.....
460c	8993	Thread (under) Take-up Thread Guard Steady Pin Set Screw.....
54332	8993	Thread (upper) Controller.....
207d	8993	“ “ “ Screw.....
46009	8993	“ “ Eyelet.....
190d	8958	“ “ “ Screw.....
54094	8993	“ “ Take-up.....
54095	8993	“ “ “ Plate.....
54716	8993	“ “ “ “ Spring ..
1449b	8993	“ “ “ “ “ Screw
54096	—	Thread (upper) Take-up complete, Nos. 1449b, 54094, 54095 and 54716.....
211f	8958	Thread (upper) Take-up Set Screw.....
46394	6560	Throat Plate with two each 665d and 46396, for 46373.....
46395	6560	Throat Plate with two each 665d and 46396, for 46374.....
46460	6560	Throat Plate with two each 665d and 46075, for 46459.....
53198	8988	Throat Plate with two each 665d and 46396, for 53197.....
742f	8993	Throat Plate Screw.....
46396	6560	“ “ Thread Retainer for 46394, 46395 and 53198.....
46075	8993	Throat Plate Thread Retainer for 46460.
665d	6561	“ “ “ “ “ Screw.....

LIST OF PARTS COMPLETE

FOR

MACHINE No. 147-26

FOR VAMPING AND FOXING SHOES. TWO NEEDLES, TWO
LOOPERS. GAUGES FROM $\frac{3}{32}$ TO $\frac{3}{16}$ INCH.
SPEED UP TO 3500

NO.	PLATE	NAME
*54001	—	Arm, upper and lower (solid) with 948d and 54034.....
42366	8901	Arm Oil Pad (braided cotton) for oiling Arm Rock Shaft Front Bearing.....
56006	8901	Arm Oil Pad (braided cotton) for oiling Arm Rock Shaft Intermediate Bearing.....
56003	8985	Arm Oil Tube with 29599, for oiling 54326
29599	8901	“ “ “ Packing (felt).....
54002	8902	“ Rock Shaft.....
54079	—	“ “ “ 54002 with 54004, 54005 and 64255.....
64386	8901	Arm Rock Shaft Bushing (back).....
446c	8901	“ “ “ “ “ Set Screw.....
64388	8901	“ “ “ “ (intermediate).....
423c	8901	“ “ “ “ “ Set Screw.....
52045	8901	Arm Rock Shaft Bushing Oil Pad (braided cotton).....
54004	8901	Arm Rock Shaft Collar with two 453c.....
453c	8901	“ “ “ “ Set Screw.....
54005	8901	“ “ “ Crank (back) with two 50083c.....
50083c	8901	Arm Rock Shaft Crank (back) Set Screw..
64255	8911	“ “ “ “ (front) with 453c..
2117	8901	“ “ “ “ “ Pin.....
453c	8901	“ “ “ “ “ Set Screw..
54105	8901	“ “ “ Flanged Bushing (front)
52045	8901	“ “ “ “ “ Oil Pad (braided cotton).....
453c	8901	Arm Rock Shaft Flanged Bushing (front) Set Screw.....
54006	8987	Arm Rotary Shaft.....
54384	—	“ “ “ 54006 with 640d, 54008, 54088, 54113, 54383, 64351 and 64355..

NO.	PLATE	NAME
54367	8985	Arm Rotary Shaft Bushing (front).....
761e	8901	“ “ “ “ “ Set Screw.....
54007	8902	“ “ “ “ (intermediate)
54089	—	“ “ “ “ “ 54007 with 64508 and 64805.....
64508	8902	Arm Rotary Shaft Bushing (intermediate) Oil Pad, long (braided cotton).....
64805	8985	Arm Rotary Shaft Bushing (intermediate) Oil Pad, short (braided cotton).....
422c	8901	Arm Rotary Shaft Bushing (intermediate) Set Screw (long).....
50084c	8901	Arm Rotary Shaft Bushing (intermediate) Set Screw (short).....
54008	8901	Arm Rotary Shaft Collar with two 1258c
1258c	8901	“ “ “ “ “ Set Screw... .
54009	8902	“ “ “ Flanged Bushing... .
54090	—	“ “ “ “ “ 54009 with 58039 and 64805.....
58039	8902	Arm Rotary Shaft Flanged Bushing Oil Pad, long (braided cotton).....
64805	8985	Arm Rotary Shaft Flanged Bushing Oil Pad, short (braided cotton).....
159f	8901	Arm Rotary Shaft Flanged Bushing Screw
49013	8904	“ “ “ “ “ Front Bearing Oil Pad (braided cotton).....
144d	8901	Arm Rotary Shaft Screw.....
15196	8902	“ Side Cover (back).....
286d	8904	“ “ “ “ “ Thumb Screw.....
54010	8904	“ “ “ (front).....
286d	8904	“ “ “ “ “ Thumb Screw.....
64259	8913	Balance Wheel with two 430c.....
430c	8901	“ “ “ Set Screw.....
54199	8987	Cloth Plate.....
54012	8902	“ “ Slide (left).....
38419	8901	“ “ “ “ “ Spring.....
725j	8904	“ “ “ “ “ Screw.....
54013	—	Cloth Plate Slide (left) complete, Nos. 38419, 54012 and two 725j.....
54055	8986	Cloth Plate Slide (right).....
38419	8904	“ “ “ “ “ Spring.....
725j	8904	“ “ “ “ “ Screw... .
54056	—	Cloth Plate Slide (right) complete, Nos. 38419, 54055 and two 725j.....
54200	—	Cloth Plate complete, Nos. 54013, 54056 and 54199.....
1011f	8904	Cloth Plate Screw (left).....
50473f	8904	“ “ “ (right).....

From the Library of the Copyright Clearance Center

NO.	PLATE	NAME
54101	8913	Cloth Plate Thread Guard.....
1235D	8904	“ “ “ “ Screw.....
54017	8902	Crank Connecting Rod with 6575, 54018, 5 4218, 54897, 57222 and two each 896E and 1057E.....
54088	---	Crank Connecting Rod 54017 with 50069c
50069c	8901	“ “ “ Ball Screw Stud
1516E	8904	“ “ “ “ “ “ Nut.....
64268	8904	Crank Connecting Rod Ball Screw Stud Washer.....
*57222	---	Crank Connecting Rod Cap (lower).....
896E	8904	“ “ “ “ “ Screw
*54018	---	“ “ “ “ (upper).....
1057E	8904	“ “ “ “ “ Screw
54897	8901	“ “ “ Oil Cup.....
54218	8904	“ “ “ “ Pad (braided cotton).....
6575	8904	Crank Connecting Rod Oil Pad Stop Pin
64269	8913	Face Plate.....
46111	8911	“ “ Pin.....
286D	8904	“ “ Thumb Screw.....
54019	8902	Feed Bar with 50429c and two 453c.....
54020	8902	“ “ Connection.....
57225	8901	“ “ Hinge Pin.....
453c	8901	“ “ “ “ Set Screw.....
54111	8902	“ Connecting Rod with 1057E, 54112 and two 896E.....
54113	---	Feed Connecting Rod 54111 with 54025..
*54112	---	“ “ “ Cap.....
896E	8904	“ “ “ “ Screw.....
1057E	8904	“ “ “ “ Clamping Screw...
54023	8911	“ “ “ Hinge Pin.....
21506	8904	“ “ “ “ “ Collar with 457c.....
457c	8904	Feed Connecting Rod Hinge Pin Collar Set Screw.....
54319	8988	Feed Dog, 17 teeth (16 teeth to the inch)
157D	8904	“ “ Screw.....
50429c	8904	“ “ Stop Screw.....
*54024	---	“ Eccentric.....
*23729	---	“ “ Body.....
51061c	8958	“ “ “ Set Screw.....
7071	8904	“ “ Clamping Washer.....
217D	8904	“ “ “ “ Screw

NO.	PLATE	NAME
54025	8985	Feed Eccentric (adjustable) complete, Nos. 217D, 1103c, 7071, 23729, 54024 and two 51061c.....
1103c	8904	Feed Regulating Screw.....
54026	8905	“ Rocking Frame with two 453c.....
54077	---	“ “ “ 54026 with 21506, 54019, 54020, 54023 and 57225.....
57234	8911	Feed Rocking Frame Hinge Pin.....
57235	8985	“ “ “ “ “ Bushing
453c	8901	“ “ “ “ “ “ Set Screw.....
453c	8901	Feed Rocking Frame Hinge Pin Set Screw
54339	8994	Looper (back) closed eye.....
1147c	8989	“ “ Set Screw.....
54340	8994	“ (front) closed eye.....
NOTE: When ordering Nos. 54339 or 54340, state gauge of machine for which required		
1120c	8958	Looper (front) Set Screw.....
54027	8989	“ Carrier with two 171D.....
171D	8958	“ “ Adjusting Screw.....
54227	8989	“ “ Connection.....
54228	8989	“ “ “ Shaft.....
54229	8989	“ “ “ “ Bushing
446c	8901	“ “ “ “ “ Set Screw.....
49013	8904	Looper Carrier Connection Shaft Oil Pad (braided cotton).....
54230	8989	Looper Carrier Driver with 54032 and four 175E.....
*54032	---	Looper Carrier Driver Cap.....
175E	8958	“ “ “ “ Screw.....
54368	8994	“ Driving Shaft and Feed Lifting Eccentric with 227D and two 64315....
54383	---	Looper Driving Shaft and Feed Lifting Eccentric 54368 with 54027, 54227, 54228 and 54230.....
*54034	8905	Looper Driving Shaft and Feed Lifting Eccentric Bracket with 761E.....
54080	8990	Looper Driving Shaft and Feed Lifting Eccentric Bracket Bushing.....
761E	8901	Looper Driving Shaft and Feed Lifting Eccentric Bracket Bushing Set Screw..
948D	8958	Looper Driving Shaft and Feed Lifting Eccentric Bracket Screw.....
64315	8990	Looper Driving Shaft and Feed Lifting Eccentric Oil Hole Plug.....

From the Library of Raymond Needle Corp.

NO.	PLATE	NAME
227D	8958	Looper Driving Shaft and Feed Lifting Eccentric Oil Hole Screw.....
40326	8990	Looper Driving Shaft and Feed Lifting Eccentric Oil Pad (braided cotton)....
640D	8958	Looper Driving Shaft and Feed Lifting Eccentric Screw.....
54061	8990	Looper Holder with 1120c and 1147c....
704J	8958	" " Screw.....
64319	8991	Needle Bar (hollow).....
54062	—	Needle Bar complete, Nos. 54064, 54065 and 64319.....
38456	8991	Needle Bar Bushing (lower).....
1133E	8958	" " " " Set Screw...
64320	8991	" " " (upper).....
1133E	8958	" " " " Set Screw...
54326	8991	" " Connecting Link.....
54329	—	" " " " 54326 with 54327 and 54328.....
54327	8991	Needle Bar Connecting Link Hinge Stud
1520E	8991	" " " " " "
		Nut.....
54328	8991	Needle Bar Connecting Stud with 211E and two 187E.....
187E	8958	Needle Bar Connecting Stud Clamping Screw.....
54064	8991	Needle Clamp with two 1498E.....
54065	8991	" " Thread Guard.....
54320	8995	" Guard.....
54038	8991	" " Holder.....
176D	8958	" " " Screw.....
219D	8991	" " Screw.....
1498E	8958	" Set Screw.....
54108	—	Oil Tube.....
54109	—	" " Bracket.....
49092	8900	" " Packing (felt).....
54110	8990	Oil Tube complete, for oiling crank connecting rod (upper bearing) Nos. 49092, 54108 and 54109.....
64330	8986	Presser Bar with 25303.....
25303	8990	" " Ball, size 1/4 in.....
64331	8911	" " Bushing (lower).....
1133E	8958	" " " " Set Screw...
38456	8991	" " " (upper).....
1133E	8958	" " " " Set Screw...
54039	8985	" " Guide Bracket with 453c, 640J and 1963.....

NO.	PLATE	NAME
640J	8958	Presser Bar Guide Bracket Adjusting Screw.....
11173	8985	Presser Bar Guide Bracket Guide.....
447C	8958	" " " " " Set Screw
1963	8985	" " " " Roller and Stud
453C	8901	" " " " Set Screw.....
57257	8911	" " Lifter.....
57258	8911	" " " Hinge Pin.....
447C	8958	" " " " Set Screw..
1872	8985	" " " Roller and Stud.....
1250C	8911	" " " Stop Screw.....
61047	8911	" " Lifting Bracket with 460C and 1872.....
64362	8996	Presser Bar Lifting Lever.....
61075	8911	" " " " Connecting Stud.....
460C	8993	Presser Bar Lifting Lever Connecting Stud Set Screw.....
54103	8905	Presser Bar Lifting Lever Extension.....
161D	8958	" " " " " Screw (left).....
176D	8958	Presser Bar Lifting Lever Extension Screw (right).....
802D	8958	Presser Bar Lifting Lever Hinge Screw.....
54040	8905	" " Spring (flat).....
38468	8990	" " " Stud.....
54321	—	" Foot.....
54322	8994	" " Spring Guide.....
725J	8904	" " " " Screw.....
54323	8994	Presser Foot complete, Nos. 725J, 54321 and 54322.....
190D	8958	Presser Foot Screw.....
574J	8958	Pressure Regulating Thumb Screw.....
1539J	8992	" " " " Lock Nut.....
54381	8994	Slack Thread Controller.....
54242	8990	" " " Clamp.....
1190D	8958	" " " " Screw....
61337	8995	" " Regulator.....
54012	8990	" " " Holder with 175E and 50150c.....
175E	8958	Slack Thread Regulator Holder Clamping Screw.....
54043	8990	Slack Thread Regulator Holder Shaft.....
24292	8990	" " " " " Collar with 1019c.....

NO.	PLATE	NAME
1019c	8958	Slack Thread Regulator Holder Shaft Collar Set Screw.....
54044	8990	Slack Thread Regulator Holder Shaft Crank (forked) with 1253c.....
1253c	8958	Slack Thread Regulator Holder Shaft Crank Set Screw.....
50150c	8958	Slack Thread Regulator Set Screw.....
2102	8964	Tension (under thread) Disc.....
51570c	8964	" " " " Regulating Thumb Nut.....
50326c	8964	Tension (under thread) Screw Stud.....
59539	-----	" " " " " 50326c with 51570c.....
59534	8964	Tension (under thread) Spring.....
59537	8964	" " " " Bushing (large).....
59538	8964	Tension (under thread) Spring Bushing (small).....
17547	8964	Tension (under thread) Thread Guide....
54070	8996	" (upper thread) Bracket.....
376D	8958	" " " " Screw....
2102	8964	" " " " Disc.....
51570c	8964	" " " " Regulating Thumb Nut.....
32572	8964	Tension (upper thread) Releasing Disc....
54988	8964	" " " " Pin.....
54071	8992	" " " " Shaft
54047	8964	" " " " " "
		Crank with 624c.....
54048	8964	Tension (upper thread) Releasing Shaft Crank Link.....
624c	8958	Tension (upper thread) Releasing Shaft Crank Set Screw.....
54990	8964	Tension (upper thread) Releasing Shaft Spring.....
316F	8958	Tension (upper thread) Releasing Shaft Stop Screw.....
1547J	8992	Tension (upper thread) Releasing Shaft Stop Screw Nut.....
50326c	8964	Tension (upper thread) Screw Stud.....
59539	-----	" " " " " 50326c with 51570c.....
59535	8964	Tension (upper thread) Spring.....
59537	8964	" " " " Bushing (large).....
59538	8964	Tension (upper thread) Spring Bushing (small).....

NO.	PLATE	NAME
17547	8964	Tension (upper thread) Thread Guide....
54204	8992	Thread Lubricating Oil Cup.....
57629	8992	" " " " Pad (felt)....
54205	8992	" " " " Thread Guide
217J	8904	" " " " " "
		Screw.....
54206	-----	Thread Lubricating Oil Cup complete, Nos. 217J, 54204, 54205 and 57629....
53225	8993	Thread (under) Eyelet (back).....
190D	8958	" " " " Screw.....
54072	8993	" " " " (front).....
64351	8994	" " " " Nipper Cam with 465c....
465c	8958	" " " " Set Screw...
38210	8993	" " " " Spring (lower)....
38211	8993	" " " " (upper)....
46247	8993	" " " " " Stop
176D	8958	" " " " Screw.....
38475	8995	" " " " Take-up with 465c.....
465c	8958	" " " " Set Screw.....
54435	8994	" " " " Staple with 5905 and 38481.....
54049	8905	Thread (under) Take-up Staple Bracket with 460c.....
965D	8993	Thread (under) Take-up Staple Bracket Screw.....
46041	8993	Thread (under) Take-up Staple Spring
190D	8958	" " " " " "
		Screw.....
38481	8994	Thread (under) Take-up Staple Thread Guard.....
590D	8958	Thread (under) Take-up Staple Thread Guard Screw.....
38482	8993	Thread (under) Take-up Stripper.....
207D	8993	" " " " " Screw..
64355	8994	" " " " Thread Guard (brass).....
64356	8993	Thread (under) Take-up Thread Guard Steady Pin.....
460c	8993	Thread (under) Take-up Thread Guard Steady Pin Set Screw.....
54331	8993	Thread (upper) Controller.....
207D	8993	" " " " Screw.....
46009	8993	" " " " Eyelet.....
190D	8958	" " " " Screw.....
54094	8993	" " " " Take-up.....
54095	8993	" " " " Plate.....
54716	8993	" " " " Spring....

NO.	PLATE	NAME
1449d	8993	Thread (upper) Take-up Plate Spring Screw.....
54096	—	Thread (upper) Take-up complete, Nos. 1449b, 54094, 54095 and 54716.....
211F	8958	Thread (upper) Take-up Set Screw.....
54324	8988	Throat Plate for 54319.....
742F	8993	" " Screw.....

ACCESSORIES

NO.	PLATE	NAME
120344	8941	Oiler (copper plated) with 120345.....
120345	8941	" Spout, 5 in. long.....
26026	8941	Screw Driver (large).....
26485	8941	" " (small).....
38487	8941	Threading Wire.....
120341	8941	Tweezers (curved).....
8908	8941	Wrench for 1520.....
19221	8941	" " 1516.....
4822	8941	" " 1547.....

MACHINE BASE WITH BELT GUARD

NO.	PLATE	NAME
54356	8980	Belt Guard with 1192c.....
27347	8985	" " Hinge Pin.....
1192c	8985	" " " " Set Screw.....
1192c	8985	" " " " Set Screw.....
54357	8980	Machine Base with 1192c.....
51072E	8995	" " Bolt with 51581E.....
51581E	8995	" " " " Nut.....
6055	8990	" " " " Washer.....
49123	8996	" " Oil Pipe.....
60884	8985	" " " " Plug.....
57285	8996	" Cushion (felt).....
948E	8958	" Screw, to fasten machine to base.....
54358	—	Machine Base with Belt Guard complete, Nos. 27347, 49123, 54356, 54357, 60884, three each 6055, 51072E and four each 948E and 57285.....

FOOT LIFTER PARTS

NO.	PLATE	NAME
6439	—	Chain, 36 in. to 45 in., with 56864 and 56865.....

NOTE: When ordering No. 6439, give length required

4879	8941	Chain Connecting Link.....
56864	8941	" Hook (large).....
56865	8985	" " (small).....
126249	8980	Treadle.....
4882	8941	" Shaft.....
126250	8941	" Spring.....
126251	8980	" Stand.....
126252	8980	Treadle complete, Nos. 4882, 126249 to 126251 and two wood screws 1 in. No. 16

KNEE LIFTER PARTS

NO.	PLATE	NAME
37563	—	Chain, length 15 in., with 56864 and 56865.....
56864	8941	" Hook (large).....
56865	8985	" " (small).....
2763	8980	Rock Shaft.....
12242	8980	" " Hanger with two wood screws 1 in. No. 10.....
6335	8980	Rock Shaft Knee Arm.....
6336	—	Rock Shaft Knee Arm complete, Nos. 2766, 2767 and 6335.....
2766	8980	Rock Shaft Knee Arm Hub with 356c.....
356c	8985	" " " " Set Screw.....
2767	8980	" " " " Plate with 356c.....
356c	8985	" " " " Set Screw.....
6337	8980	" " Lifting Bracket with two 356c.....
7125	8980	" " " " Hook.....
356c	8985	" " " " " Set Screw.....
356c	8985	" " " " " Set Screw.....
2770	8980	" " Stop Dog with 356c.....
356c	8985	" " " " " Set Screw.....
23767	8980	Rock Shaft complete, Nos. 2763, 2770, 6336, 6337, 7125 and two 12242.....

BENCH STAND

NO.	PLATE	NAME
79611	—	Bench Stand with 5604, 9370, two 41538, three wood screws $1\frac{1}{4}$ in. No. 14, four 60656 and sixteen wood screws $\frac{5}{8}$ in. No. 7.....
41538	—	Flush Bolt with Plate complete, Nos. 126247, 126248 and four brass wood screws $\frac{5}{8}$ in. No. 4.....
126247	8952	Flush Bolt.....
126248	8952	" " Plate.....
60656	8952	Hinge.....
9370	8952	Slide Spring.....
5604	8952	" " Pin.....

THREAD UNWINDER

FOR SIX SPOOLS FOR 147-24 MACHINE

NO.	PLATE	NAME
225395	8953	Spool Rest (for two spools) with 201018c.....
225388	8953	" " Rod.....
200383c	8985	" " " Set Screw.....
201018c	8985	" " " Set Screw.....
202490	8953	" Stand with 200383c.....
225391	8953	Thread Guide.....
201696j	8995	" " Lock Nut.....
225392	8953	" " Rod with 208e and 225393.....
208e	8985	" " " Screw.....
225393	8995	" " " Washer.....
225378	8997	Thread Unwinder complete, Nos. 201696j, 202490, 225388, 225392, three 225395, six 225391 and three wood screws $\frac{7}{8}$ in. No. 12.....
27739	8996	Thread Cone (wood) for large cones.....
225390	8996	" " Holder, for inverted cones.....

NOTE: Nos. 27739 and 225390 are used with, but not included in, 225378

THREAD UNWINDER

FOR FOUR SPOOLS FOR 147-26 MACHINE

NO.	PLATE	NAME
225395	8953	Spool Rest (for two spools) with 201018c.....
225388	8953	" " Rod.....
200383c	8985	" " " Set Screw.....
201018c	8985	" " " Set Screw.....
202490	8953	" Stand with 200383c.....
225391	8953	Thread Guide.....
201696j	8995	" " Lock Nut.....
225392	8953	" " Rod with 208e and 225393.....
208e	8985	" " " Screw.....
225393	8995	" " " Washer.....
225398	8953	Thread Unwinder complete, Nos. 201696j, 202490, 225388, 225392, two 225395, four 225391 and three wood screws $\frac{7}{8}$ in. No. 12.....
27739	8996	Thread Cone (wood) for large cones.....
225390	8996	" " Holder, for inverted cones.....

NOTE: Nos. 27739 and 225390 are used with, but not included in, 225398

NUMERICAL LIST OF PARTS
FOR
MACHINES
Nos. 147-24 and 147-26

NUMERICAL LIST OF PARTS

NO.	PLATE	NAME
144d	S901	Arm Rotary Shaft Screw
157d	S904	Feed Dog Screw
159f	S901	Arm Rotary Shaft Flanged Bushing Screw
161d	S958	Presser Bar Lifting Lever Extension Screw (left)
171d	S958	Looper Carrier Adjusting Screw for 54027
175e	S958	" " Driver Cap Screw for 54230
175e	S958	Slack Thread Regulator Holder Clamping Screw for 54042
176d	S958	Needle Guard Holder Screw
176d	S958	Presser Bar Lifting Lever Extension Screw (right)
176d	S958	Thread (under) Nipper Spring Screw
187e	S958	Needle Bar Connecting Stud Clamping Screw for 54328
190d	S958	Presser Foot Screw
190d	S958	Slack Thread Controller Clamp Screw
190d	S958	Thread (under) Eyelet (back) Screw
190d	S958	" " Take-up Staple Spring Screw
190d	S958	Thread (upper) Eyelet Screw
207d	S993	" (under) Take-up Stripper Screw
207d	S993	" (upper) Controller Screw
208e	S985	" Unwinder Thread Guide Rod Screw for 225392
211f	S958	Thread (upper) Take-up Set Screw for 54328
217d	S904	Feed Eccentric Clamping Washer Screw for 54025
217d	S904	Thread Lubricating Oil Cup Thread Guide Screw for 54206
219d	S991	Needle Guard Screw
227d	S958	Looper Driving Shaft and Feed Lifting Eccentric Oil Hole Screw for 54368 and 54440
229d	S958	Looper (front) Needle Guard Screw for 54372
286d	S904	Arm Side Cover (back) Thumb Screw
286d	S904	" " (front) Thumb Screw
286d	S904	Face Plate Thumb Screw
316f	S958	Tension (upper thread) Releasing Shaft Stop Screw

NUMERICAL LIST OF PARTS

NO.	PLATE	NAME
337D	6561	Presser Foot Guide (left) Screw for 46173
337D	6561	" " " (right) Screw for 46126
337D	6561	Presser Foot Guide Screw (back) for 46299 and 46303
356c	8958	Rock Shaft Knee Arm Hub Set Screw for 2766
356c	8958	Rock Shaft Knee Plate Set Screw for 2767
356c	8985	" " Lifting Bracket Hook Set Screw for 6337
356c	8985	Rock Shaft Lifting Bracket Set Screw for 6337
356c	8985	Rock Shaft Stop Dog Set Screw for 2770
376D	8958	Tension (upper thread) Bracket Screw
422c	8901	Arm Rotary Shaft Bushing (intermediate) Set Screw (long)
423c	8901	Arm Rock Shaft Bushing (intermediate) Set Screw
430c	8904	Balance Wheel Set Screw for 46220 and 64259
446c	8901	Arm Rock Shaft Bushing (back) Set Screw
446c	8901	Looper Carrier Connection Shaft Bushing Set Screw
447c	8958	Presser Bar Guide Bracket Guide Set Screw
447c	8958	Presser Bar Lifter Hinge Pin Set Screw
453c	8901	Arm Rock Shaft Collar Set Screw for 54004
453c	8901	Arm Rock Shaft Crank (front) Set Screw for 64255
453c	8901	Arm Rock Shaft Flanged Bushing (front) Set Screw
453c	8901	Feed Bar Hinge Pin Set Screw for 54019
453c	8901	" Rocking Frame Hinge Pin Bushing Set Screw
453c	8901	Feed Rocking Frame Hinge Pin Set Screw for 54026
453c	8901	Presser Bar Guide Bracket Set Screw for 54039
457c	8904	Feed Connecting Rod Hinge Pin Collar Set Screw for 21506
457F	8904	Needle Clamp Collar Set Screw for 46119
457F	8904	" Set Screw for 46119
460c	8993	Presser Bar Lifting Lever Connecting Stud Set Screw for 61017
460c	8993	Thread (under) Take-up Thread Guard Steady Pin Set Screw for 54019

NUMERICAL LIST OF PARTS

NO.	PLATE	NAME
465c	8958	Thread (under) Nipper Cam Set Screw for 64351
465c	8958	Thread (under) Take-up Set Screw for 38475 and 54441
574J	8958	Pressure Regulating Thumb Screw
590D	8958	Looper Thread Guard Screw for 54370
590D	8958	Thread (under) Take-up Staple Thread Guard Screw for 54435
590D	8958	Thread (under) Take-up Staple Thread Guard (left) Screw for 54341
590D	8958	Thread (under) Take-up Staple Thread Guard (right) Screw for 54341
624c	8958	Tension (upper thread) Releasing Shaft Crank Set Screw for 54047
640D	8958	Looper Driving Shaft and Feed Lifting Eccentric Screw for 54384 and 54448
640J	8958	Presser Bar Guide Bracket Adjusting Screw for 54039
665D	6561	Presser Foot Guide Screw (front) for 46299 and 46303
665D	6561	Throat Plate Thread Retainer Screw for 46394, 46395, 46460 and 53198
704J	8958	Looper Holder Screw
725J	8904	Cloth Plate Slide (left) Spring Screw for 54013
725J	8904	Cloth Plate Slide (right) Spring Screw for 54056, 54298 and 54300
725J	8904	Presser Foot Spring Guide Screw for 54323
742F	8993	Throat Plate Screw
761E	8901	Arm Rotary Shaft Bushing (front) Set Screw
761E	8901	Looper Driving Shaft and Feed Lifting Eccentric Bracket Bushing Set Screw for 54034
802D	8958	Presser Bar Lifting Lever Hinge Screw
896E	8904	Crank Connecting Rod Cap (lower) Screw for 54017
896E	8904	Feed Connecting Rod Cap Screw for 54111
948D	8958	Looper Driving Shaft and Feed Lifting Eccentric Bracket Screw for 54001 and 54182
948E	8958	Machine Screw, to fasten machine to base, for 54358
965D	8993	Thread (under) Take-up Staple Bracket Screw
1011F	8904	Cloth Plate Screw (left)

NO.	PLATE	NAME
1019c	8958	Slack Thread Regulator Holder Shaft Collar Set Screw for 24292.....
1057E	8901	Crank Connecting Rod Cap (upper) Screw for 54017.....
1057E	8904	Feed Connecting Rod Clamping Screw for 54111.....
1103c	8904	Feed Regulating Screw for 54025.....
1120c	8958	Looper (front) Set Screw for 54061.....
1133E	8958	Needle Bar Bushing (lower) Set Screw...
1133E	8958	" " " (upper) Set Screw...
1133E	8958	Presser Bar Bushing (lower) Set Screw...
1133E	8958	" " " (upper) Set Screw...
1147c	8989	Looper (back) Set Screw for 54061.....
1192c	8985	Belt Guard Hinge Pin Set Screw for 54357
1192c	8985	" " Set Screw for 54356.....
1235D	8904	Cloth Plate Thread Guard Screw.....
1250c	8911	Presser Bar Lifter Stop Screw.....
1253c	8958	Slack Thread Regulator Holder Shaft Crank Set Screw for 54044.....
1253c	8958	Tension (upper thread, automatic) Cam Set Screw for 46383.....
1258c	8901	Arm Rotary Shaft Collar Set Screw for 54008.....
1284D	8991	Oil Cup Regulating Screw for 54189.....
1423J	8991	" " Screw for 147-24 Machine.....
1449D	8993	Thread (upper) Take-up Plate Spring Screw for 54096.....
1498F	8958	Needle Set Screw for 54064.....
1508J	8992	Tension (upper thread, automatic) Body Nut for 147-24 Machine.....
1516E	8904	Crank Connecting Rod Ball Screw Stud Nut.....
1520E	8991	Needle Bar Connecting Link Hinge Stud Nut.....
1539J	8992	Pressure Regulating Thumb Screw Lock Nut.....
1547J	8992	Tension (upper thread) Releasing Shaft Stop Screw Nut.....
1560c	8992	Tension (upper thread, automatic) Regulating Thumb Nut for 53213.....
1872	8985	Presser Bar Lifter Roller and Stud for 61047.....
1963	8985	Presser Bar Guide Bracket Roller and Stud for 54039.....
2026	8991	Oil Cup Regulating Screw Spring for 54189

NO.	PLATE	NAME
2102	8964	Tension (under thread) Disc.....
2102	8964	" (upper thread, automatic) Disc for 147-24 Machine.....
2102	8964	Tension (upper thread) Disc.....
2117	8901	Arm Rock Shaft Crank (front) Pin.....
2763	8980	Rock Shaft for 23767.....
2766	8980	" " Knee Arm Hub with 356c, for 6336.....
2767	8980	Rock Shaft Knee Plate with 356c, for 6336
2770	8980	" " Stop Dog with 356c, for 23767
4822	8941	Wrench for 1547 (Accessories).....
4879	8911	Chain Connecting Link.....
4882	8941	Treadle Shaft for 126252.....
5604	8952	Bench Stand Slide Spring Pin for 79611..
6055	8990	Machine Base Bolt Nut Washer for 54358
6335	8980	Rock Shaft Knee Arm for 6336.....
6336	—	Rock Shaft Knee Arm complete for 23767, Nos. 2766, 2767 and 6335.....
6337	8980	Rock Shaft Lifting Bracket with two 356c, for 23767.....
6439	—	Chain, 36 in. to 45 in., with 56864 and 56865.....
6575	8904	Crank Connecting Rod Oil Pad Stop Pin for 54017.....
7071	8904	Feed Eccentric Clamping Washer for 54025.....
7125	8980	Rock Shaft Lifting Bracket Hook for 23767.....
8908	8941	Wrench for 1520 (Accessories).....
9370	8952	Bench Stand Slide Spring for 79611.....
11173	8985	Presser Bar Guide Bracket Guide.....
12242	8980	Rock Shaft Hanger with two wood screws 1 in. No. 10, for 23767.....
15196	8902	Arm Side Cover (back).....
17547	8964	Tension (under thread) Thread Guide....
17547	8964	" (upper thread) Thread Guide for 147-26 Machine.....
19221	8941	Wrench for 1516 (Accessories).....
21506	8904	Feed Connecting Rod Hinge Pin Collar with 457c, for 54077.....
*23729	—	Feed Eccentric Body for 54025.....
23767	8980	Rock Shaft complete, Nos. 2763, 2770, 6336, 6337, 7125 and two 12242.....
24292	8990	Slack Thread Regulator Holder Shaft Collar with 1019c.....
25303	8990	Presser Bar Ball, size 1/4 in., for 64330....
26026	8941	Screw Driver, large (Accessories).....

NO.	PLATE	NAME
26276	8911	Presser Foot Hinge Pin for 46299 and 46303
26485	8941	Screw Driver, small (Accessories).....
27347	8985	Belt Guard Hinge Pin for 54358.....
27739	8996	Thread Unwinder Thread Cone (wood) for large cones, for 225378 and 225398..
29599	8901	Arm Oil Tube Packing (felt) for 56003 ..
32572	8964	Tension (upper thread, automatic) Releasing Disc for 147-24 Machine.....
32572	8964	Tension (upper thread) Releasing Disc ..
37563	-----	Chain, length 15 in., with 56864 and 56865
38100	8991	Oil Cup Packing (felt) for 54189.....
38210	8993	Thread (under) Nipper Spring (lower)...
38211	8993	" " " " (upper)...
38419	8904	Cloth Plate Slide (left) Spring for 54013 ..
38419	8904	" " " (right) Spring for 54056, 54298 and 54300.....
38456	8991	Needle Bar Bushing (lower).....
38456	8991	Presser Bar Bushing (upper)
38468	8990	" " Spring Stud
38475	8995	Thread (under) Take-up with 465c, for 147-26 Machine.....
38481	8994	Thread (under) Take-up Staple Thread Guard for 54435
38481	8994	Thread (under) Take-up Staple Thread Guard (right) for 54341
38482	8993	Thread (under) Take-up Stripper.....
38487	8941	Threading Wire (Accessories).....
40326	8990	Looper Driving Shaft and Feed Lifting Eccentric Oil Pad (braided cotton)....
41538	---	Bench Stand Flush Bolt with Plate complete for 79611, Nos. 126247, 126248 and four brass wood screws $\frac{3}{8}$ in. No. 4
42366	8901	Arm Oil Pad (braided cotton) for oiling Arm Rock Shaft Front Bearing.....
46009	8993	Thread (upper) Eyelet.....
46041	8993	" (under) Take-up Staple Spring ..
46075	8993	Throat Plate Thread Retainer for 46460 ..
46105	8989	Looper (front) Needle Guard Pin for 46377
46111	8911	Face Plate Pin.....
46115	8989	Looper Thread Guard (double) for 54370
46118	8991	Needle Clamp Body for 46122
46119	8991	" " Collar with 46120 and three 457c, for 46122
46120	8991	Needle Clamp Thread Guard for 46119 ..
46121	8991	" " Washer for 46122.....

NO.	PLATE	NAME
46122	-----	Needle Clamp complete for 54238, Nos. 46118, 46119 and 46121.....
46126	6561	Presser Foot (right guide) with 337D and 46127, for 147-24 Machine.....
46127	6561	Presser Foot Guide (right) for 46126....
46173	6561	" " (left guide) with 337D and 46174, for 147-24 Machine
46174	6561	Presser Foot Guide (left) for 46173.....
46220	8986	Balance Wheel, $2\frac{1}{4}$ in. pulley, with two 430c, for 147-24 Machine.....
46247	8993	Thread (under) Nipper Spring (upper) Stop.....
46296	6561	Presser Foot Guide (left) for 46299.....
46297	-----	" " Plate for 46299
46298	-----	" " Shank for 46299.....
46299	6561	Presser Foot (side hinged) with left guide, complete, for 147-24 Machine, Nos. 337D, 665D, 26276 and 46296 to 46298..
46300	6561	Presser Foot Guide (right) for 46303.....
46301	-----	" " Plate for 46303
46302	-----	" " Shank for 46303
46303	6561	Presser Foot (side hinged) with right guide, complete, for 147-24 Machine, Nos. 337D, 665D, 26276 and 46300 to 46302.....
46373	6560	Feed Dog, 18 teeth (16 teeth to the inch) for $\frac{1}{2}$ in. to $\frac{3}{4}$ in., $\frac{3}{16}$ in. to $\frac{1}{2}$ in. and $\frac{1}{32}$ in. to $\frac{3}{64}$ in. gauges, for 147-24 Machine
46374	6560	Feed Dog, 18 teeth (16 teeth to the inch) for $\frac{1}{2}$ in. to $\frac{3}{4}$ in., $\frac{1}{4}$ in. to $\frac{1}{32}$ in. and $\frac{1}{32}$ in. to $\frac{3}{64}$ in. gauges, for 147-24 Machine
46377	8989	Looper (front) Needle Guard with 46105, for 54372.....
46383	8992	Tension (upper thread, automatic) Cam with two 1253c, for 54192
46385	8992	Tension (upper thread, automatic) Screw Stud Releasing Pin for 147-24 Machine
46387	8992	Tension (upper thread, automatic) Spring for 147-24 Machine
46394	6560	Throat Plate with two each 665D and 46396, for 46373, for 147-24 Machine..
46395	6560	Throat Plate with two each 665D and 46396, for 46374, for 147-24 Machine...
46396	6560	Throat Plate Thread Retainer for 46394, 46395 and 53198.....

NO.	PLATE	NAME
46159	6560	Feed Dog, 18 teeth (16 teeth to the inch) for $\frac{1}{32}$ in. to $\frac{5}{64}$ in., $\frac{1}{8}$ in. to $\frac{3}{32}$ in. and $\frac{1}{32}$ in. to $\frac{5}{64}$ in. gauges, for 147-24 Machine
46160	6560	Throat Plate with two each 665D and 46075, for 46459, for 147-24 Machine...
49013	8904	Arm Rotary Shaft Front Bearing Oil Pad (braided cotton).....
49013	8904	Looper Carrier Connection Shaft Oil Pad (braided cotton).....
49092	8990	Oil Tube Packing (felt) for 54110.....
49123	8996	Machine Base Oil Pipe for 54358.....
50069c	8904	Crank Connecting Rod Ball Screw Stud for 51088.....
50083c	8901	Arm Rock Shaft Crank (back) Set Screw for 54005 and 54184.....
50084c	8901	Arm Rotary Shaft Bushing (intermediate) Set Screw (short).....
50106c	8992	Tension (upper thread, automatic) Screw Stud for 53213.....
50150c	8958	Slack Thread Regulator Set Screw for 54042.....
50326c	8964	Tension (under thread) Screw Stud for 59539.....
50326c	8964	Tension (upper thread) Screw Stud for 59539.....
50129c	8904	Feed Dog Stop Screw for 54019.....
50173F	8904	Cloth Plate Screw (right).....
51061c	8958	Feed Eccentric Body Set Screw for 54025
51072E	8995	Machine Base Bolt with 51581E, for 54358
51570c	8961	Tension (under thread) Regulating Thumb Nut for 59539.....
51570c	8961	Tension (upper thread) Regulating Thumb Nut for 59539.....
51581E	8995	Machine Base Bolt Nut for 51072E.....
52045	8901	Arm Rock Shaft Bushing Oil Pad (braided cotton).....
52045	8901	Arm Rock Shaft Flanged Bushing (front) Oil Pad (braided cotton).....
53197	8988	Feed Dog, 18 teeth (16 teeth to the inch) for $\frac{1}{32}$ in. to $\frac{5}{64}$ in., $\frac{3}{32}$ in. to $\frac{1}{12}$ in. and $\frac{1}{32}$ to $\frac{5}{64}$ in. gauges, for 147-24 Machine...
53198	8988	Throat Plate with two each 665D and 46396, for 53197, for 147-24 Machine..
53213	—	Tension (upper thread, automatic) Screw Stud 50106c with 1560c, for 147-24 Machine.....
53225	8993	Thread (under) Eyelet (back).....

NO.	PLATE	NAME
*54001	—	Arm, upper and lower (solid) with 948D and 54034, for 147-26 Machine.....
54002	8902	Arm Rock Shaft for 54079.....
54004	8901	“ “ “ Collar with two 453c, for 54079 and 54192.....
54005	8901	Arm Rock Shaft Crank (back) with two 50083c, for 54079.....
54006	8987	Arm Rotary Shaft for 54384 and 54448...
54007	8902	“ “ “ Bushing (intermediate) for 54089.....
54008	8901	Arm Rotary Shaft Collar with two 1258c, for 54384 and 54448.....
54009	8902	Arm Rotary Shaft Flanged Bushing for 54090.....
54010	8904	Arm Side Cover (front).....
54012	8902	Cloth Plate Slide (left) for 54013.....
54013	—	Cloth Plate Slide (left) complete for 54200, 54301 and 54302, Nos. 38419, 54012 and two 725J.....
54017	8902	Crank Connecting Rod with 6575, 54018, 54218, 54897, 57222 and two each 896E and 1057E, for 54088.....
*54018	—	Crank Connecting Rod Cap (upper) for 54017.....
54019	8902	Feed Bar with 50429c and two 453c, for 54077.....
54020	8902	Feed Bar Connection for 54077.....
54023	8911	“ Connecting Rod Hinge Pin for 54077
*54024	—	“ Eccentric for 54025.....
54025	8985	Feed Eccentric (adjustable) complete for 54113, Nos. 217D, 1103c, 7071, 23729, 54024 and two 51061c.....
54026	8905	Feed Rocking Frame with two 453c, for 54077.....
54027	8989	Looper Carrier with two 171D, for 54383 and 54447.....
*54032	—	Looper Carrier Driver Cap for 54230.....
*54034	8905	“ Driving Shaft and Feed Lifting Eccentric Bracket with 761E, for 54001 and 54182.....
54038	8991	Needle Guard Holder.....
54039	8985	Presser Bar Guide Bracket with 453c, 640J and 1963.....
54040	8905	Presser Bar Spring (flat).....
54042	8990	Slack Thread Regulator Holder with 175E and 50150c.....

NO.	PLATE	NAME
54043	8990	Slack Thread Regulator Holder Shaft.....
54044	8990	“ “ “ “ “ Crank (forked) with 1253c.....
54047	8964	Tension (upper thread) Releasing Shaft Crank with 624c.....
54048	8964	Tension (upper thread) Releasing Shaft Crank Link.....
54049	8905	Thread (under) Take-up Staple Bracket with 460c.....
54055	8986	Cloth Plate Slide (right) for 54056.....
54056	—	Cloth Plate Slide (right) complete for 54200, Nos. 38419, 54055 and two 725j
54061	8990	Looper Holder with 1120c and 1147c....
54062	—	Needle Bar complete for 147-26 Machine, Nos. 54064, 54065 and 64319.....
54064	8991	Needle Clamp with two 1498e, for 54062..
54065	8991	“ “ Thread Guard for 54062....
54070	8996	Tension (upper thread) Bracket for 147-26 Machine.....
54071	8992	Tension (upper thread) Releasing Shaft for 147-26 Machine.....
54072	8993	Thread (under) Eyelet (front).....
54077	—	Feed Rocking Frame 54026 with 21506, 54019, 54020, 54023 and 57225.....
54079	—	Arm Rock Shaft 54002 with 54004, 54005 and 64255, for 147-26 Machine.....
54080	8990	Looper Driving Shaft and Feed Lifting Eccentric Bracket Bushing.....
54088	—	Crank Connecting Rod 54017 with 50069c, for 54384 and 54448.....
54089	—	Arm Rotary Shaft Bushing (intermediate) 54007 with 64508 and 64805.....
54090	—	Arm Rotary Shaft Flanged Bushing 54009 with 58039 and 64805.....
54094	8993	Thread (upper) Take-up for 54096.....
54095	8993	“ “ “ Plate for 54096.....
54096	—	Thread (upper) Take-up complete, Nos. 1449b, 54094, 54095 and 54716.....
54103	8905	Presser Bar Lifting Lever Extension.....
54104	8913	Cloth Plate Thread Guard.....
54105	8901	Arm Rock Shaft Flanged Bushing (front)
54108	—	Oil Tube for 54110.....
54109	—	“ “ Bracket for 54110.....
54110	8990	Oil Tube complete, for oiling crank con- necting rod (upper bearing) Nos. 49092, 54108 and 54109.....

NO.	PLATE	NAME
54111	8902	Feed Connecting Rod with 1057e, 54112 and two 896e, for 54113.....
*54112	—	Feed Connecting Rod Cap for 54111.....
54113	—	“ “ “ 54111 with 54025, for 54384 and 54448.....
*54182	—	Arm, upper and lower (solid) with 948d and 54034, for 147-24 Machine.....
54183	8987	Arm Rock Shaft for 54192.....
54184	8985	“ “ “ Crank (back) with two 50083c, for 54192.....
54188	8991	Oil Cup for 54189.....
54189	—	Oil Cup complete, for oiling upper thread, for 147-24 Machine, Nos. 1284d, 2026, 38100 and 54188.....
54192	—	Arm Rock Shaft 54183 with 46383, 54004, 54184 and 64255, for 147-24 Machine..
54199	8987	Cloth Plate for 54200.....
54200	—	Cloth Plate complete for 147-26 Machine, Nos. 54013, 54056 and 54199.....
54204	8992	Thread Lubricating Oil Cup for 54206..
54205	8992	“ “ “ “ Thread Guide for 54206.....
54206	—	Thread Lubricating Oil Cup complete for 147-26 Machine, Nos. 217j, 54204, 54205 and 57629.....
54216	8992	Tension (upper thread, automatic) Body for 147-24 Machine.....
54218	8904	Crank Connecting Rod Oil Pad (braided cotton) for 54017.....
54227	8989	Looper Carrier Connection for 54383 and 54447.....
54228	8989	Looper Carrier Connection Shaft for 54383 and 54447.....
54229	8989	Looper Carrier Connection Shaft Bushing
54230	8989	“ “ Driver with 54032 and four 175e, for 54383 and 54447.....
54238	—	Needle Bar complete for 147-24 Machine, Nos. 46122 and 64319.....
54239	8995	Needle Guard, for gauges $\frac{3}{8}$ in. to $\frac{1}{2}$ in. between the second and third needles, for 147-24 Machine.....
54241	8990	Slack Thread Controller for 147-24 Ma- chine.....
54242	8990	Slack Thread Controller Clamp.....
54243	8990	“ “ Regulator for 147-24 Ma- chine.....

NO.	PLATE	NAME
54244	8992	Tension (upper thread, automatic) Thread Guide for 147-24 Machine.....
54245	8996	Tension (upper thread) Bracket for 147-24 Machine.....
54246	8992	Tension (upper thread) Releasing Shaft for 147-24 Machine.....
54296	8987	Cloth Plate for 54301 and 54302.....
54297	8986	“ “ Slide (right) for 54298.....
54298	—	Cloth Plate Slide (right) complete for 54301, Nos. 38419, 54297 and two 725J
54299	8986	Cloth Plate Slide (right) for 54300.....
54300	—	Cloth Plate Slide (right) complete for 54302, Nos. 38419, 54299 and two 725J
54301	—	Cloth Plate complete, for $\frac{1}{2}$ in. to $\frac{3}{4}$ in., $\frac{3}{8}$ in. to $\frac{1}{2}$ in. and $\frac{1}{2}$ in. to $\frac{3}{4}$ in. gauges, for 147-24 Machine, Nos. 54013, 54296 and 54298.....
54302	—	Cloth Plate complete, for $\frac{1}{2}$ in. to $\frac{3}{4}$ in., $\frac{3}{8}$ in. to $\frac{1}{2}$ in. and $\frac{1}{2}$ in. to $\frac{3}{4}$ in. gauges, for 147-24 Machine, Nos. 54013, 54296 and 54300.....
54319	8988	Feed Dog, 17 teeth (16 teeth to the inch) for 147-26 Machine.....
54320	8995	Needle Guard for 147-26 Machine.....
54321	—	Presser Foot for 54323.....
54322	8994	“ “ Spring Guide for 54323.....
54323	8994	Presser Foot complete for 147-26 Machine, Nos. 725J, 54321 and 54322.....
54324	8988	Throat Plate for 54319, for 146-26 Machine
54325	8985	Presser Bar Bushing (lower) for 147-24 Machine.....
54326	8991	Needle Bar Connecting Link for 54329...
54327	8991	“ “ “ “ Hinge Stud for 54329.....
54328	8991	Needle Bar Connecting Stud with 211F and two 187E, for 54329.....
54329	—	Needle Bar Connecting Link 54326 with 54327 and 54328.....
54331	8993	Thread (upper) Controller for 147-26 Machine.....
54332	8993	Thread (upper) Controller for 147-24 Machine.....
54333	8992	Tension (upper thread, automatic) Body Releasing Pin for 147-24 Machine.....
54335	8995	Needle Guard, for gauges $\frac{1}{8}$ in. to $\frac{1}{4}$ in. between the second and third needles, for 147-24 Machine.....

NO.	PLATE	NAME
54336	8995	Needle Guard, for gauges $\frac{3}{8}$ in. to $\frac{1}{2}$ in. between the second and third needles, for 147-24 Machine.....
54339	8994	Looper (back) closed eye, for 147-26 Machine.....
54340	8994	Looper (front) closed eye, for 147-26 Machine.....
54341	8993	Thread (under) Take-up Staple with 38481, 54342 and two 590D.....
54342	8993	Thread (under) Take-up Staple Thread Guard (left) for 54341.....
54356	8980	Belt Guard with 1192c, for 54358.....
54357	8980	Machine Base with 1192c, for 54358.....
54358	—	Machine Base with Belt Guard complete, Nos. 27347, 49123, 54356, 54357, 60884, three each 6055, 51072E and four each 948E and 57285.....
54367	8985	Arm Rotary Shaft Bushing (front).....
54368	8994	Looper Driving Shaft and Feed Lifting Eccentric with 227D and two 64315, for 54383.....
54370	8989	Looper (back) with 590D and 46115, for 147-24 Machine.....
54371	8989	Looper (front) for 54372.....
54372	—	“ “ 54371 with 46377 and two 229D, for 147-24 Machine.....
54381	8994	Slack Thread Controller for 147-26 Machine.....
54383	—	Looper Driving Shaft and Feed Lifting Eccentric 54368 with 54027, 54227, 54228 and 54230, for 54384.....
54384	—	Arm Rotary Shaft 54006 with 640D, 54008, 54088, 54113, 54383, 64351 and 64355, for 147-26 Machine.....
54435	8994	Thread (upper) Take-up Staple with 590D and 38481, for 147-26 Machine.....
54440	8990	Looper Driving Shaft and Feed Lifting Eccentric with 227D and two 64315, for 54447.....
54441	8995	Thread (under) Take-up with 465c, for 147-24 Machine.....
54447	—	Looper Driving Shaft and Feed Lifting Eccentric 54440 with 54027, 54227, 54228 and 54230, for 54448.....
54448	—	Arm Rotary Shaft 54006 with 640D, 54008, 54088, 54113, 54447, 64351 and 64355, for 147-24 Machine.....

NO.	PLATE	NAME
54716	8993	Thread (upper) Take-up Plate Spring for 54096.....
54897	8904	Crank Connecting Rod Oil Cup for 54017
54988	8961	Tension (upper thread) Releasing Pin....
54990	8961	" " " " Shaft Spring
56003	8985	Arm Oil Tube with 29599, for oiling 54326
56006	8901	" " Pad (braided cotton) for oiling Arm Rock Shaft Intermediate Bearing
56861	8941	Chain Hook (large) for 6439 and 37563..
56865	8985	" " (small) for 6439 and 37563..
57076	8961	Tension (upper thread) Thread Guide (double) for 147-24 Machine.....
*57222	-----	Crank Connecting Rod Cap (lower) for 54017.....
57225	8901	Feed Bar Hinge Pin for 54077.....
57234	8911	" Rocking Frame Hinge Pin.....
57235	8985	" " " " " Bushing
57257	8911	Presser Bar Lifter.....
57258	8911	" " " Hinge Pin.....
57285	8996	Machine Cushion (felt) for 54358.....
57629	8992	Thread Lubricating Oil Cup Pad (felt) for 54206
58039	8902	Arm Rotary Shaft Flanged Bushing Oil Pad, long (braided cotton) for 54090...
59534	8964	Tension (under thread) Spring.....
59535	8964	" (upper thread) Spring.....
59537	8964	" (under thread) Spring Bushing (large).....
59537	8964	Tension (upper thread) Spring Bushing (large).....
59538	8964	Tension (under thread) Spring Bushing (small).....
59538	8964	Tension (upper thread) Spring Bushing (small).....
59539	-----	Tension (under thread) Screw Stud 50326c with 51570c.....
59539	-----	Tension (upper thread) Screw Stud 50326c with 51570c
60656	8952	Bench Stand Hinge for 79611
60884	8985	Machine Base Oil Pipe Plug for 54358...
61017	8911	Presser Bar Lifting Bracket with 460c and 1872
61075	8911	Presser Bar Lifting Lever Connecting Stud
64255	8911	Arm Rock Shaft Crank (front) with 453c, for 54079 and 54192.....

NO.	PLATE	NAME
64259	8913	Balance Wheel with two 430c, for 147-26 Machine.....
64268	8904	Crank Connecting Rod Ball Screw Stud Washer.....
64269	8913	Face Plate.....
64315	8990	Looper Driving Shaft and Feed Lifting Eccentric Oil Hole Plug for 54368 and 54440
64319	8991	Needle Bar (hollow) for 54062 and 54238
64320	8991	" " Bushing (upper).....
64330	8986	Presser Bar with 25303.....
64331	8911	" " Bushing (lower) for 147-26 Machine.....
64337	8995	Slack Thread Regulator for 147-26 Machine.....
64351	8994	Thread (under) Nipper Cam with 465c, for 54384 and 54448.....
64355	8994	Thread (under) Take-up Thread Guard (brass) for 54384 and 54448.....
64356	8993	Thread (under) Take-up Thread Guard Steady Pin.....
64362	8996	Presser Bar Lifting Lever.....
64386	8901	Arm Rock Shaft Bushing (back).....
64388	8901	" " " " (intermediate)
64508	8902	" Rotary Shaft Bushing (intermediate) Oil Pad, long (braided cotton) for 54089
64805	8985	Arm Rotary Shaft Bushing (intermediate) Oil Pad, short (braided cotton) for 54089
64805	8985	Arm Rotary Shaft Flanged Bushing Oil Pad, short (braided cotton) for 54090
79611	-----	Bench Stand with 5604, 9370, two 41538, three wood screws 1¼ in. No. 14, four 60656 and sixteen wood screws ⅝ in. No. 7.....
120341	8941	Tweezers, curved (Accessories).....
120344	8941	Oiler (copper plated) with 120345 (Accessories).....
120345	8941	Oiler Spout, 5 in. long, for 120344.....
126247	8952	Bench Stand Flush Bolt for 41538
126248	8952	" " " " Plate for 41538..
Nos. 126249 to 126251 for 126252		
126249	8980	Treadle
126250	8941	" Spring
126251	8980	" Stand

NUMERICAL LIST OF PARTS

NO.	PLATE	NAME
126252	8980	Treadle complete, Nos. 4882, 126249 to 126251 and two wood screws 1 in. No. 16
200383c	8985	Thread Unwinder Spool Rest Rod Set Screw for 202490.....
201018c	8985	Thread Unwinder Spool Rest Set Screw for 225395.....
201696j	8995	Thread Unwinder Thread Guide Lock Nut for 225378 and 225398.....
202490	8953	Thread Unwinder Spool Stand with 200383c, for 225378 and 225398.....
225378	8997	Thread Unwinder complete, for six spools, for 147-24 Machine, Nos. 201696j, 202490, 225388, 225392, three 225395, six 225391 and three wood screws $\frac{7}{8}$ in. No. 12.....
225388	8953	Thread Unwinder Spool Rest Rod for 225378 and 225398.....
225390	8996	Thread Unwinder Thread Cone Holder, for inverted cones, for 225378 and 225398.....
225391	8953	Thread Unwinder Thread Guide for 225378 and 225398.....
225392	8953	Thread Unwinder Thread Guide Rod with 208e and 225393, for 225378 and 225398
225393	8995	Thread Unwinder Thread Guide Rod Washer for 225392.....
225395	8953	Thread Unwinder Spool Rest (for two spools) with 201018c, for 225378 and 225398.....
225398	8953	Thread Unwinder complete, for four spools, for 147-26 Machine, Nos. 201696j, 202490, 225388, 225392, two 225395, four 225391 and three wood screws $\frac{7}{8}$ in. No. 12.....

**ILLUSTRATIONS OF PARTS
FOR
MACHINES
Nos. 147-24 and 147-26**

PLATE 6560—FULL SIZE

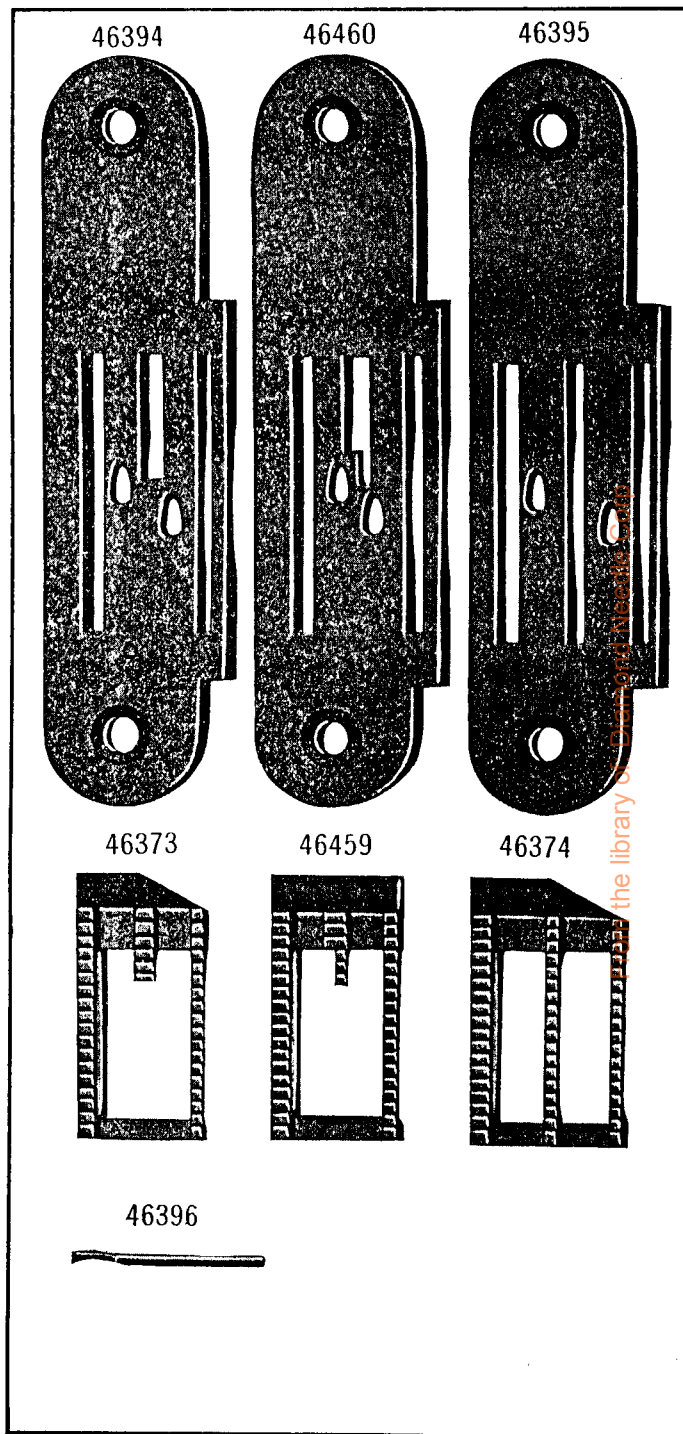


PLATE 6561—FULL SIZE

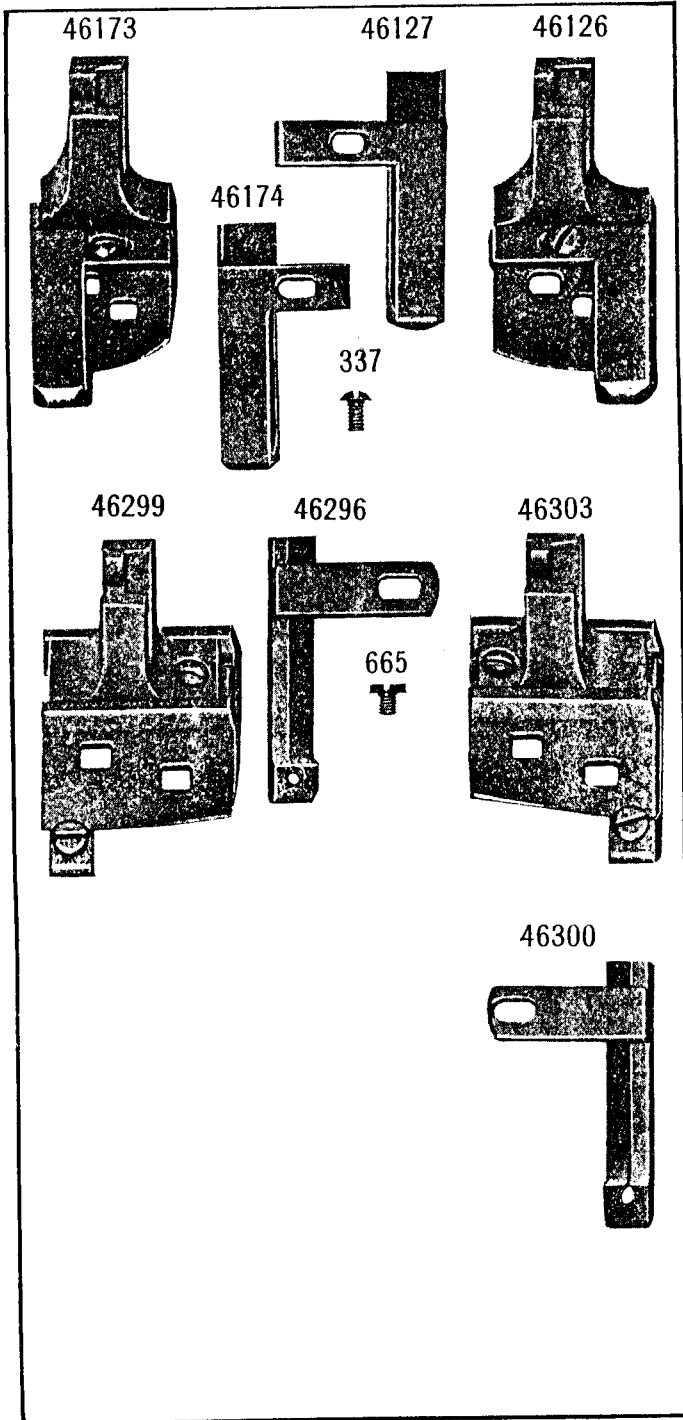


PLATE 8901—FULL SIZE

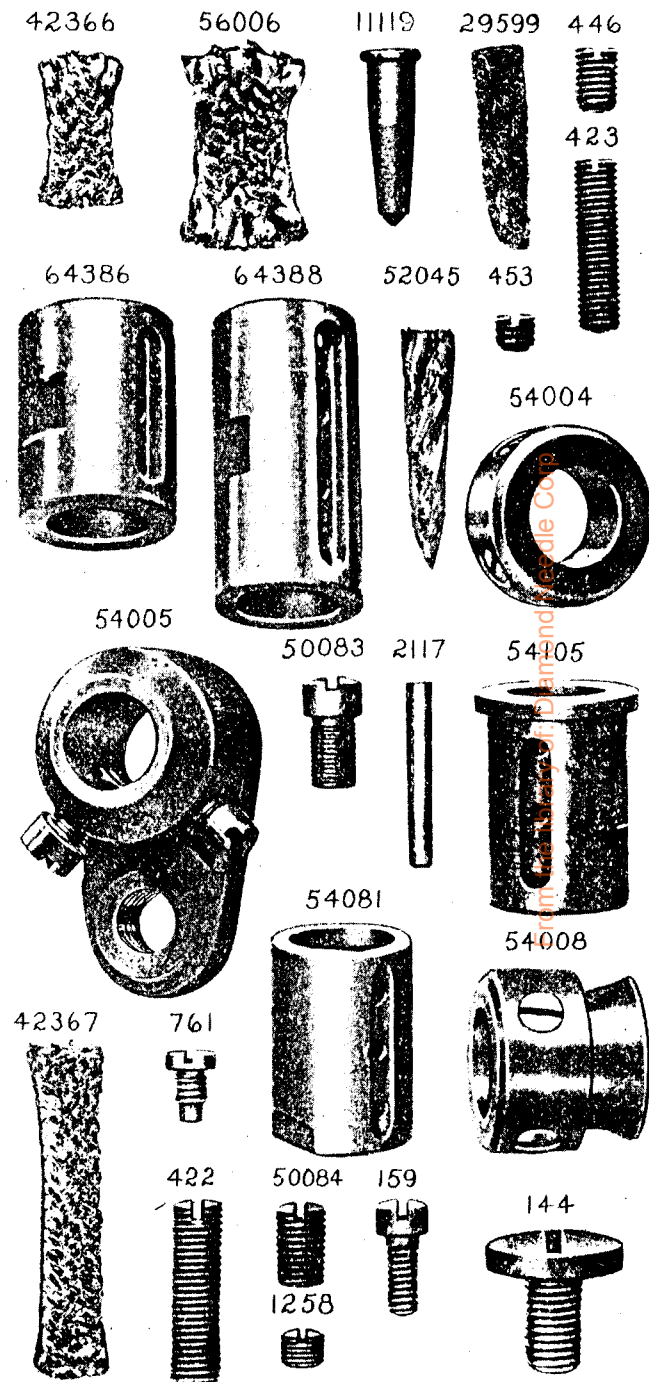
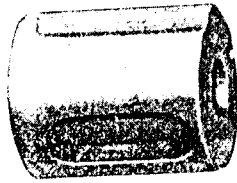


PLATE 8902—ONE-HALF SIZE

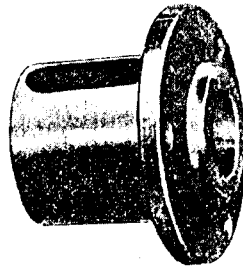
54002



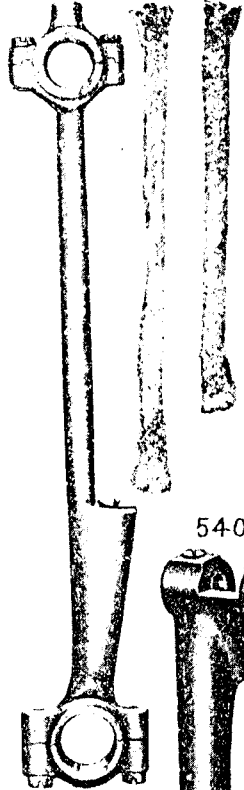
54007



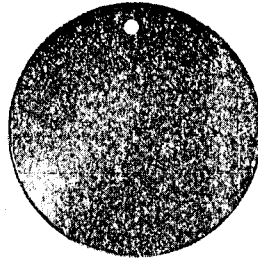
54009



54017 64508 58039



15196



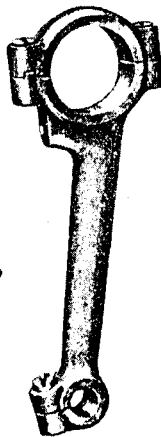
54012



54019



54111



54020

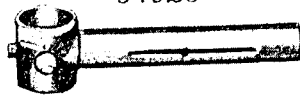


PLATE 8904—FULL SIZE

49013



286



54010



430



50473



1011



38419



725



1235



50069



1516



64268



896



1057



54897



57225



21506



457



54218



6575



50429



157



443



7071



61171



1103



21332



934



Digitized by the University of Michigan Library

PLATE 8905—ONE-HALF SIZE

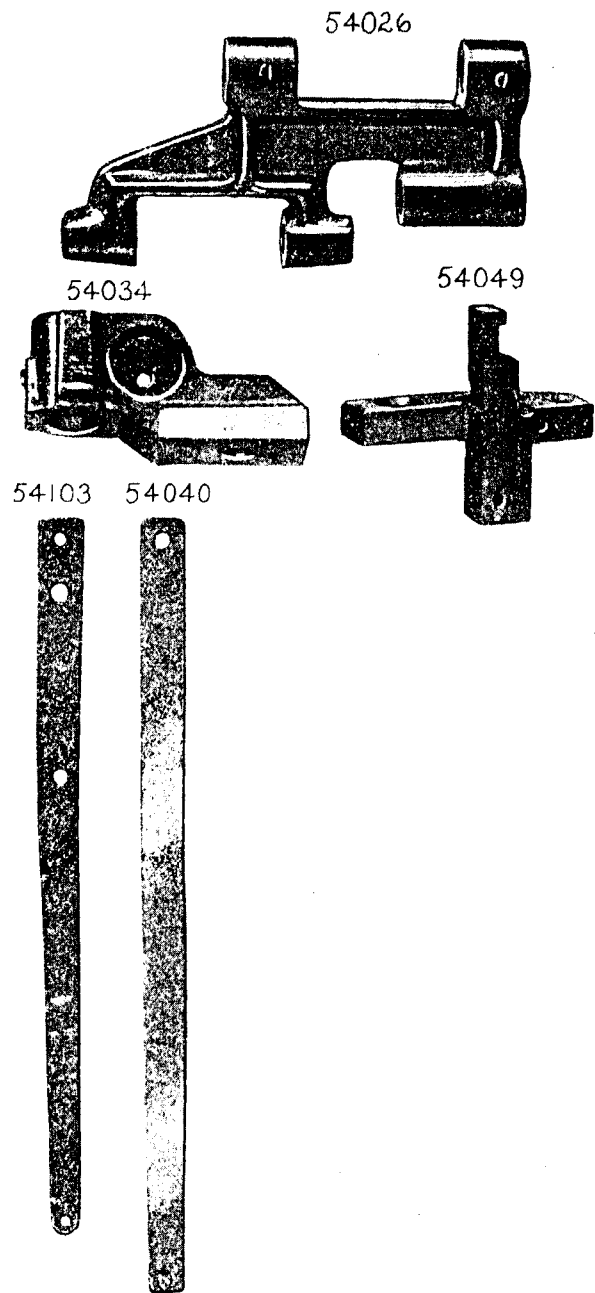


PLATE 8911—FULL SIZE

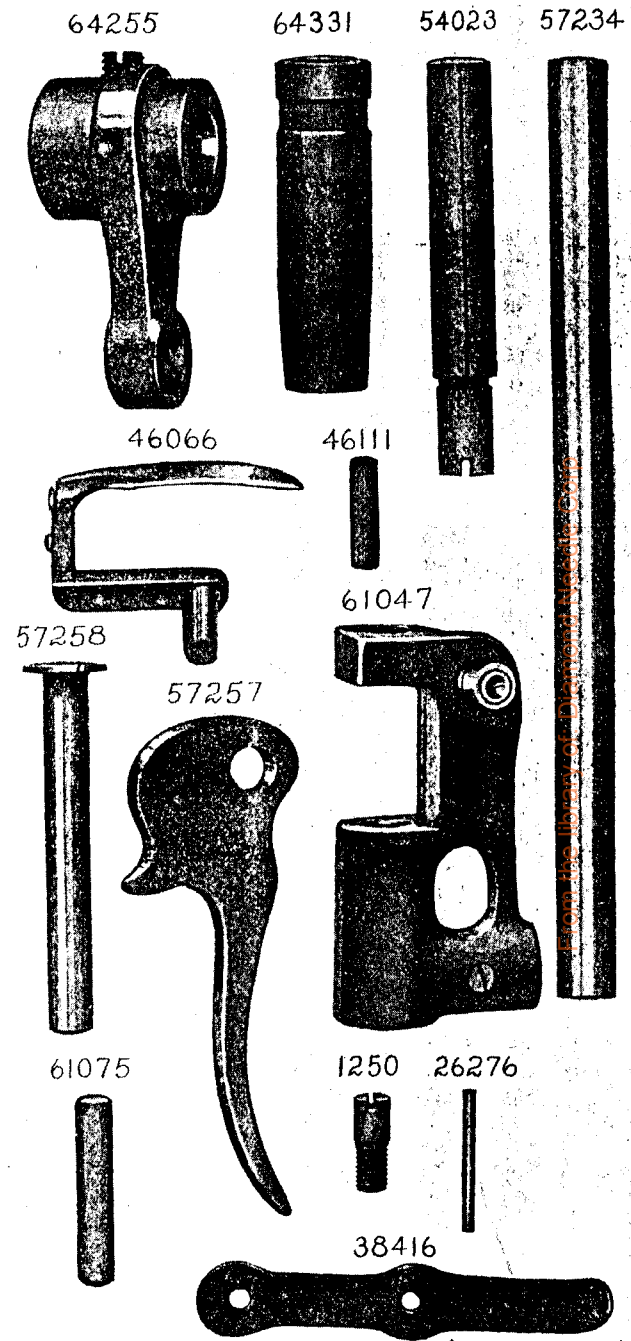
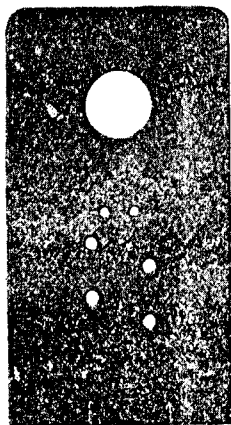


PLATE 8913—ONE-HALF SIZE

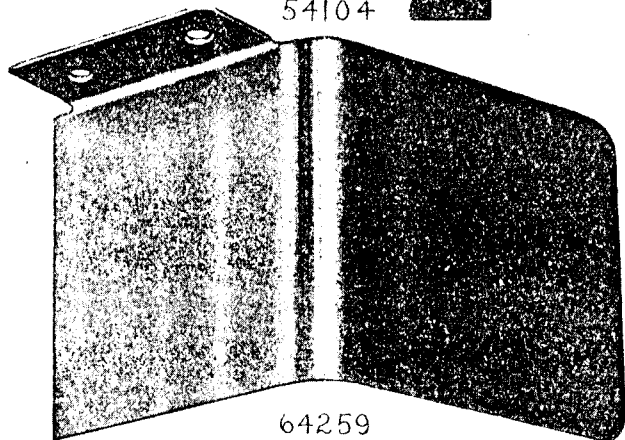
54014



64269



54104



64259

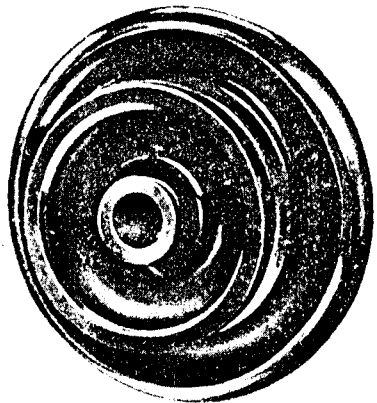
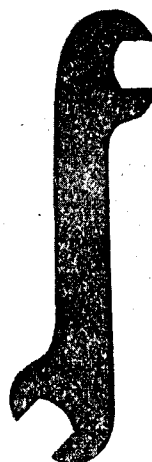


PLATE 8941—ONE-HALF SIZE

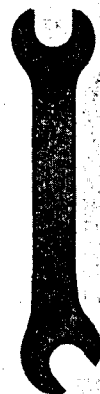
19221



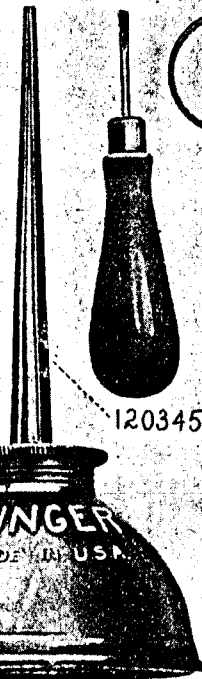
4822



8908



120344 26485

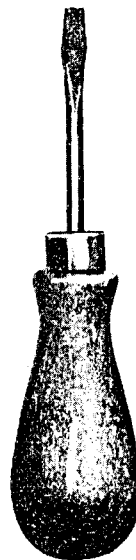


120345

38487



26026



120341



4879



56864



126250



4882



From the library of: Diamond Needle Corp.

PLATE 8952—FULL SIZE

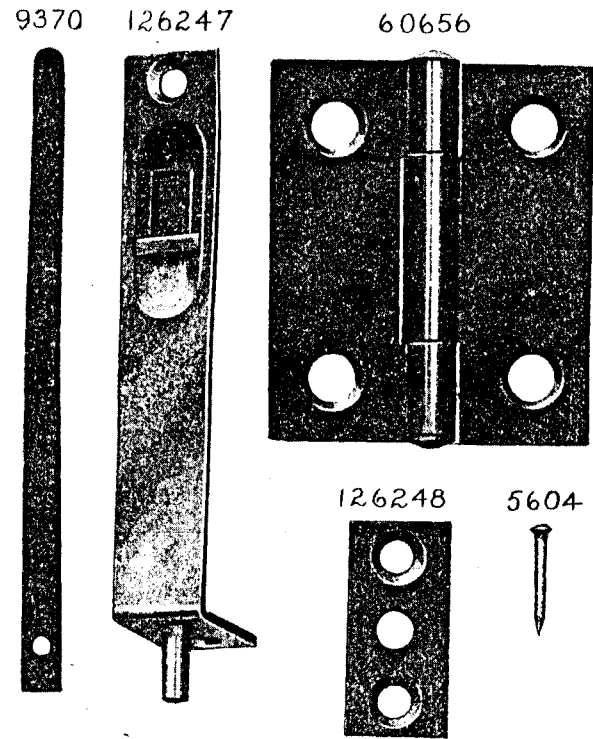


PLATE 8953—ONE-SIXTH SIZE

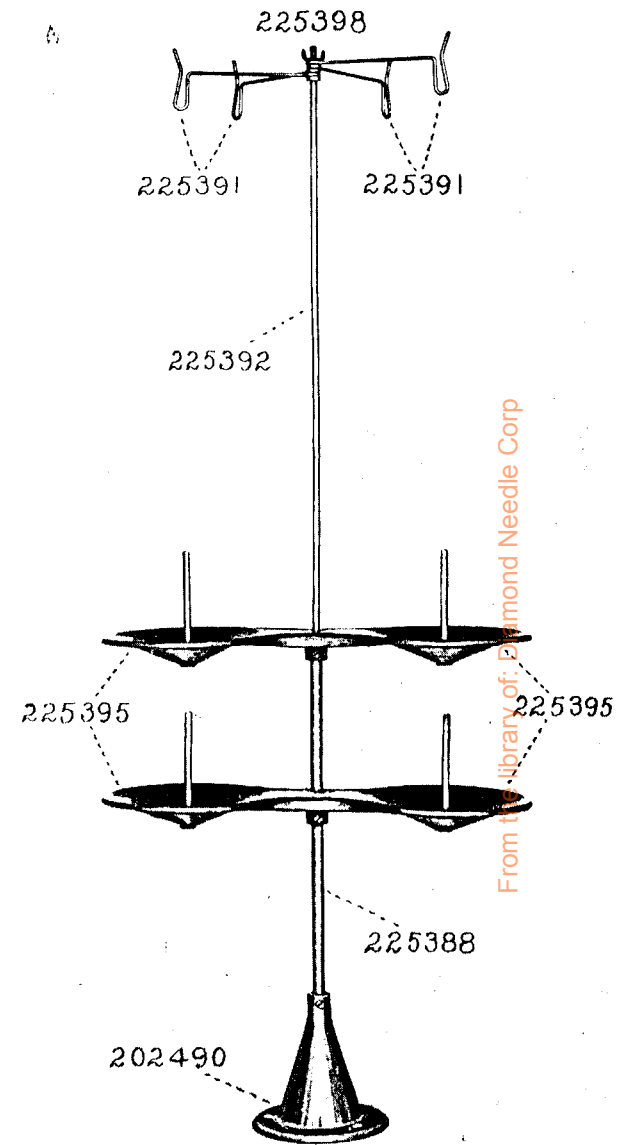


PLATE 8958—FULL SIZE

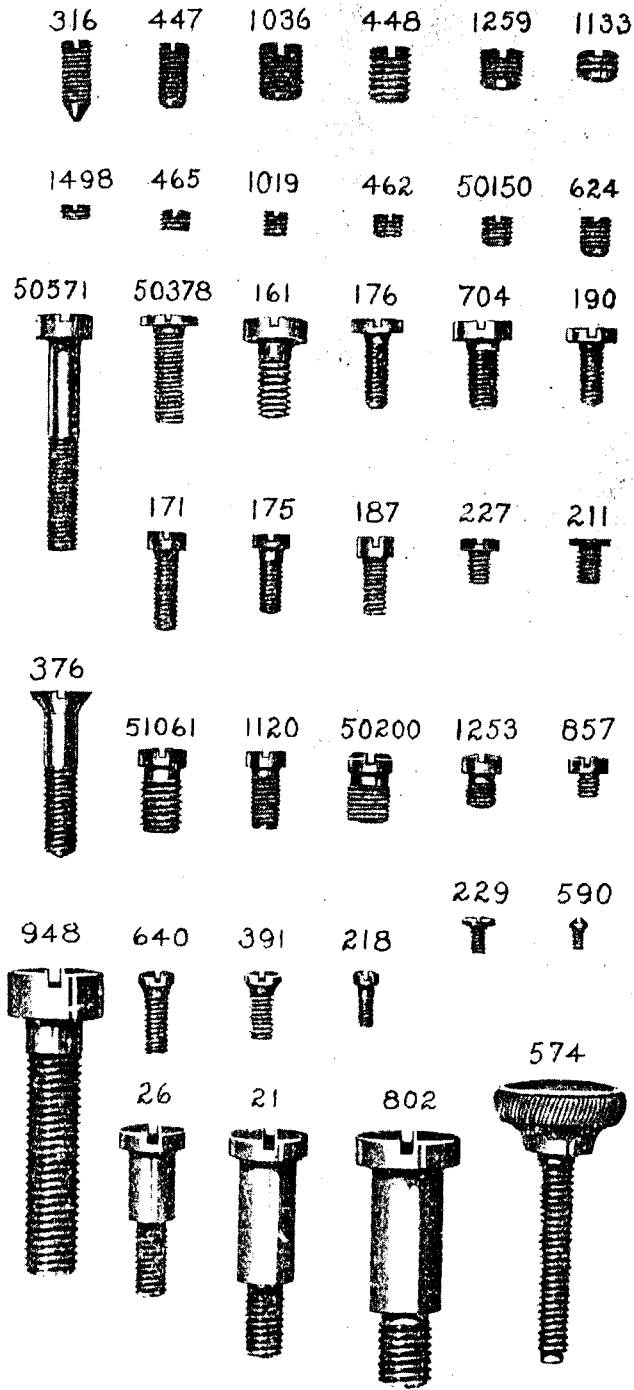
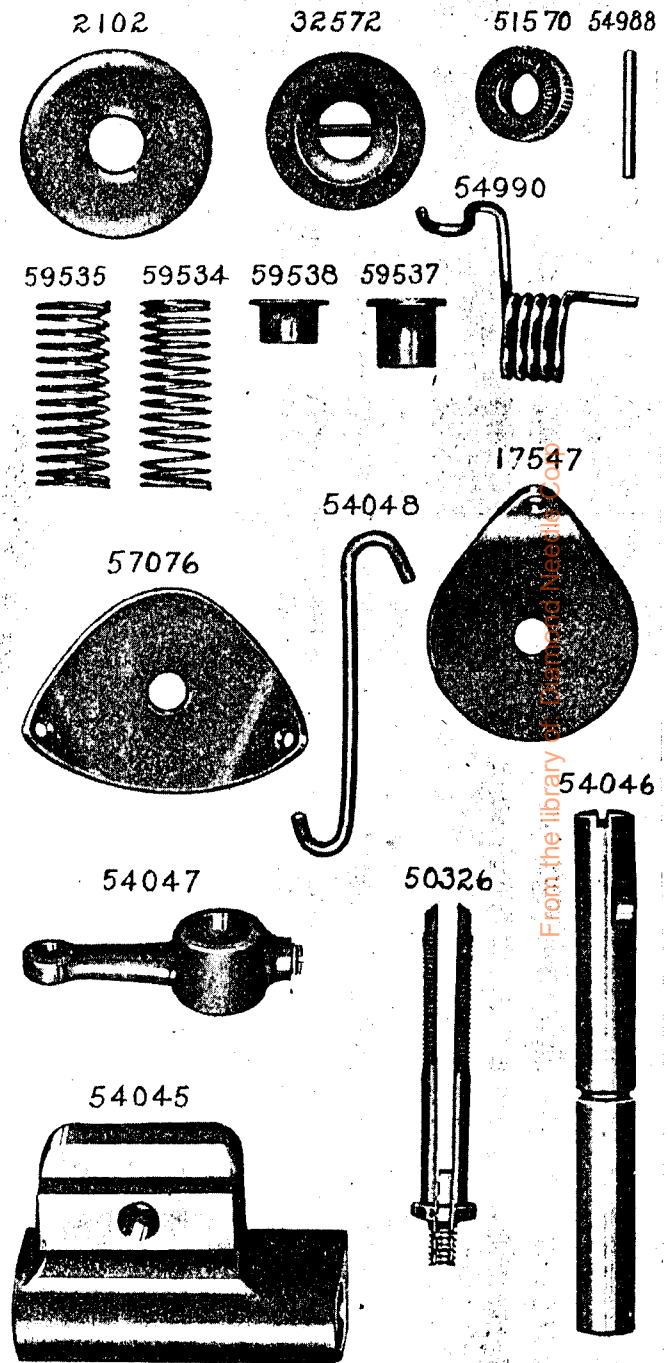


PLATE 8964—FULL SIZE



From the library of Armstrong & Associates

PLATE 8980—ONE-FOURTH SIZE

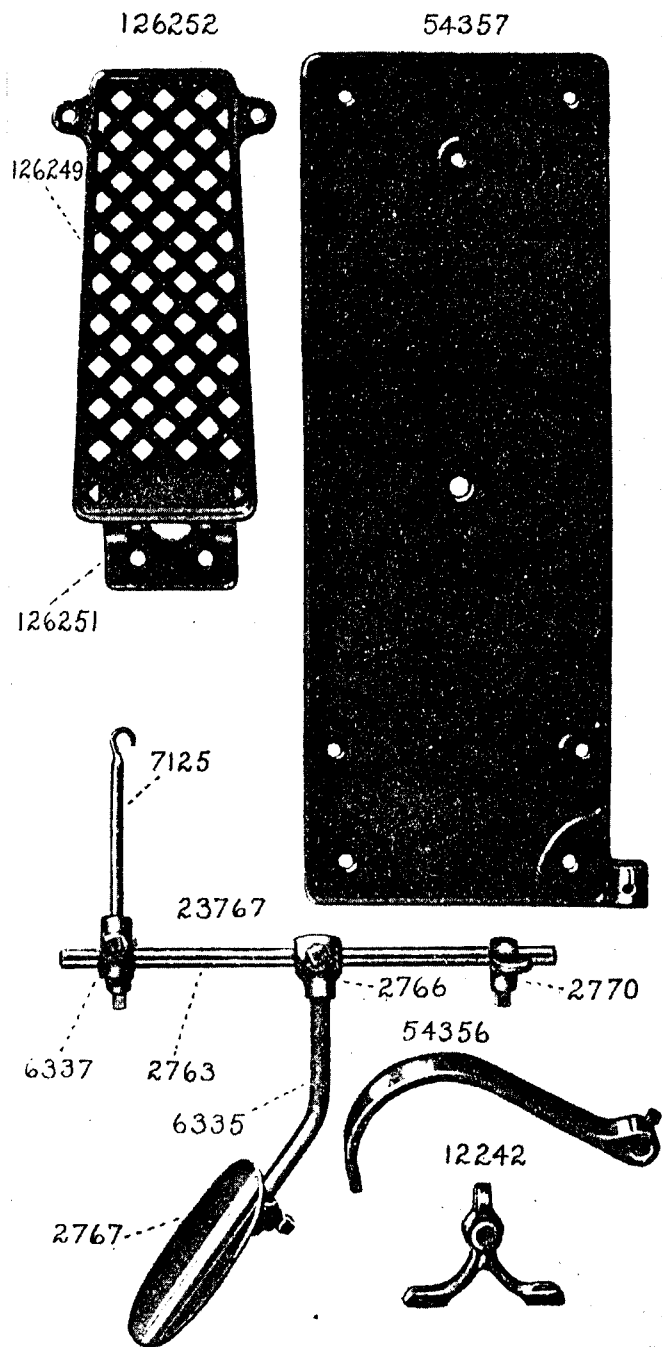


PLATE 8985—FULL SIZE

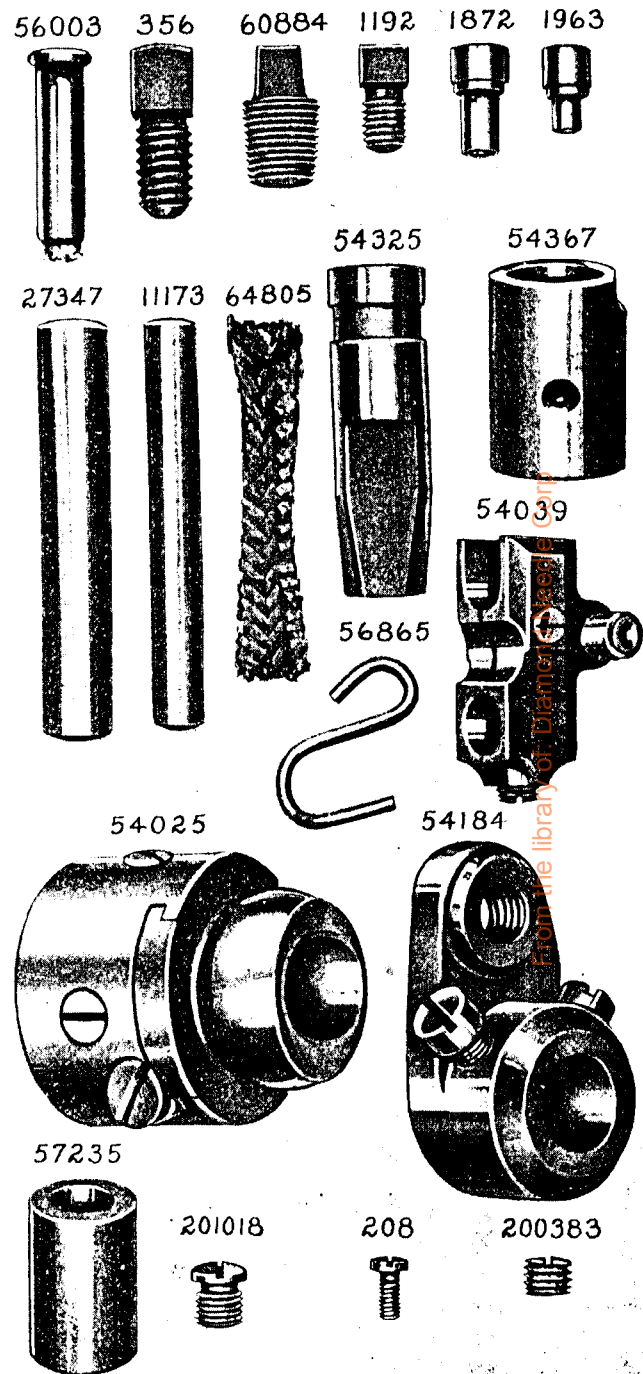
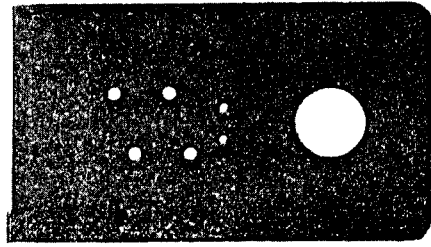
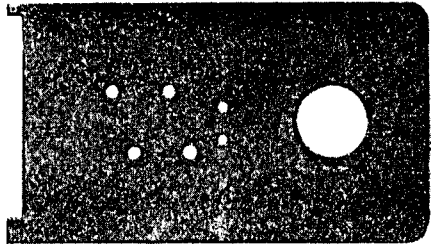


PLATE 8986—ONE-HALF SIZE

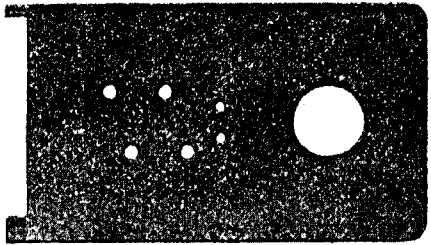
54055



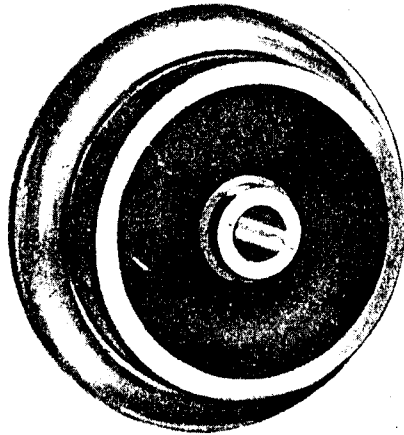
54297



54299



46220

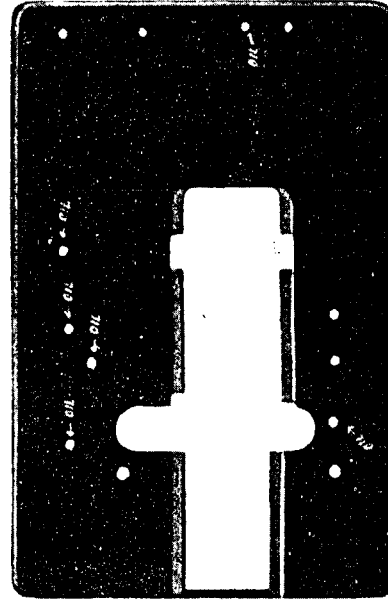


64330

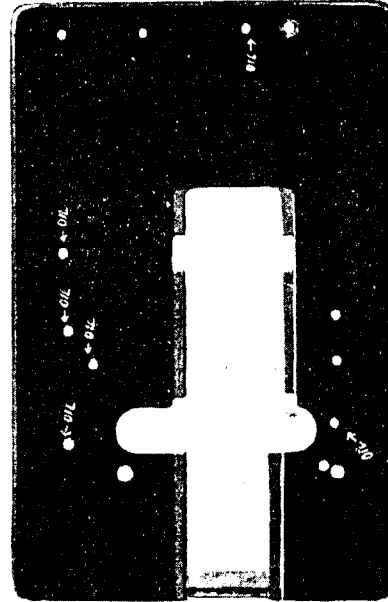


PLATE 8987—ONE-FOURTH SIZE

54296



54199



54006



54183



From the library of: DiamondNeedle.com

PLATE 8988—FULL SIZE

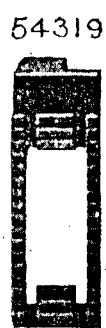
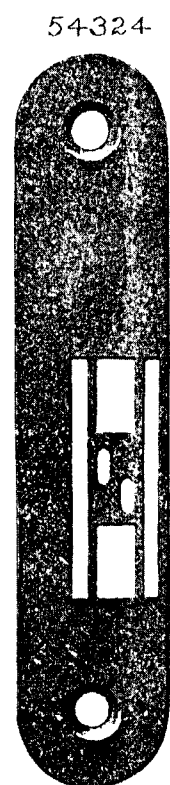
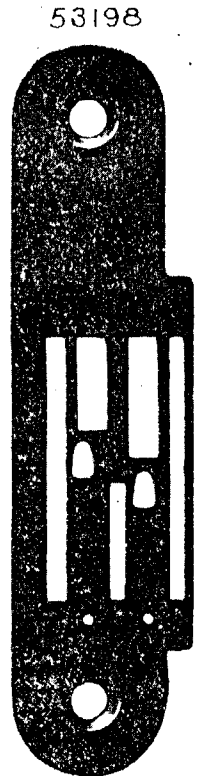
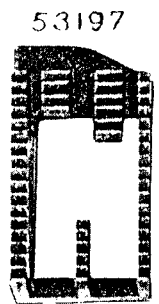
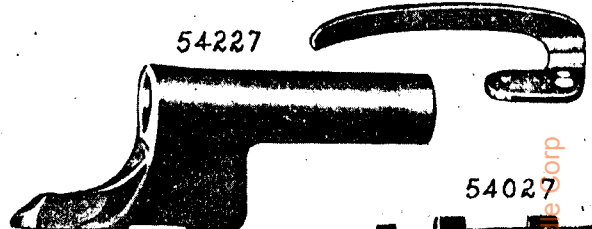
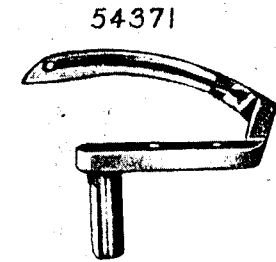
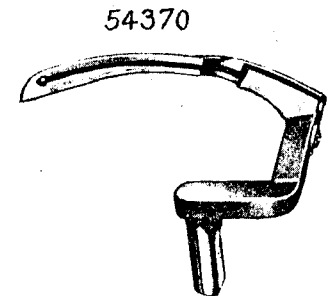
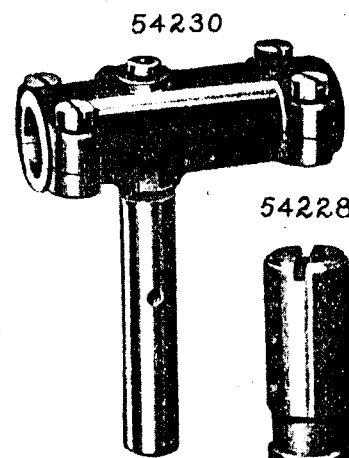
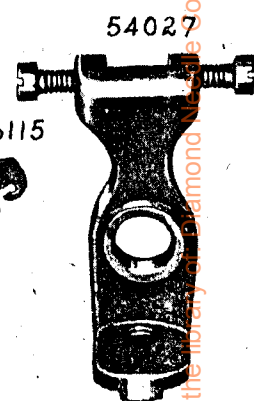
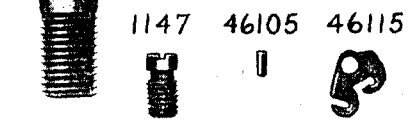


PLATE 8989—FULL SIZE



46377



54228



54229



From the library of the Diamond Manufacturing Corp

PLATE 8990—FULL SIZE

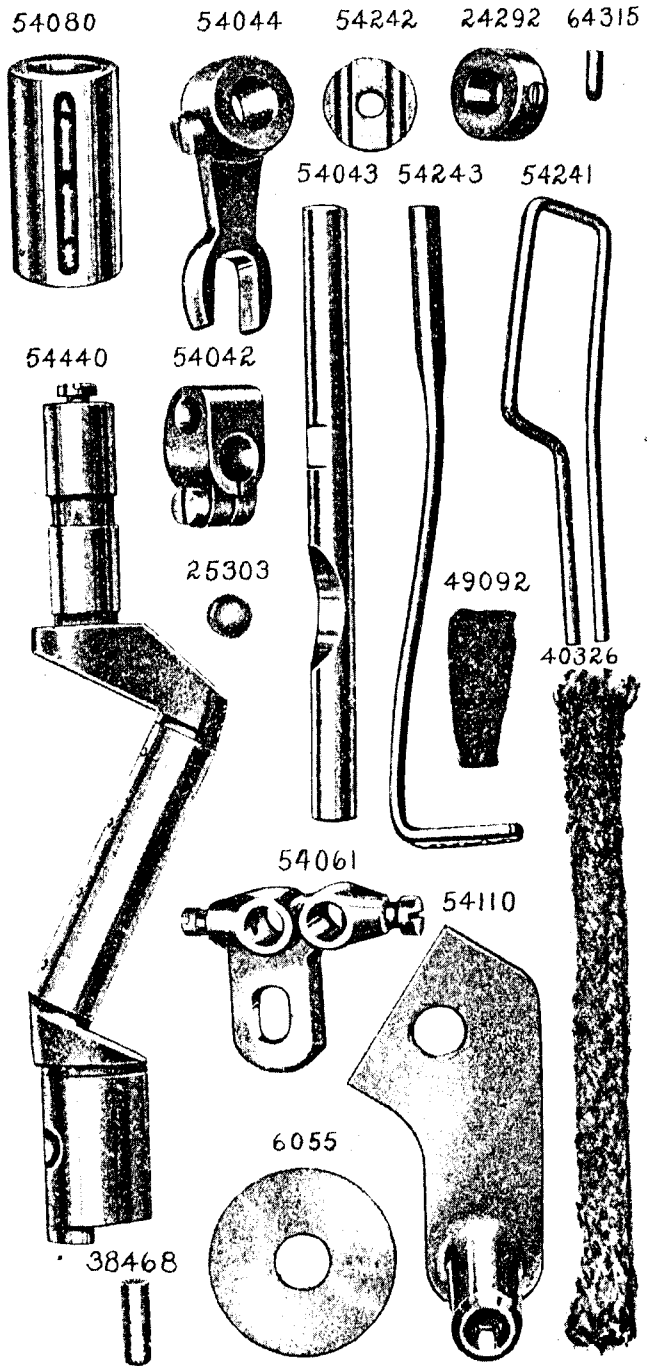
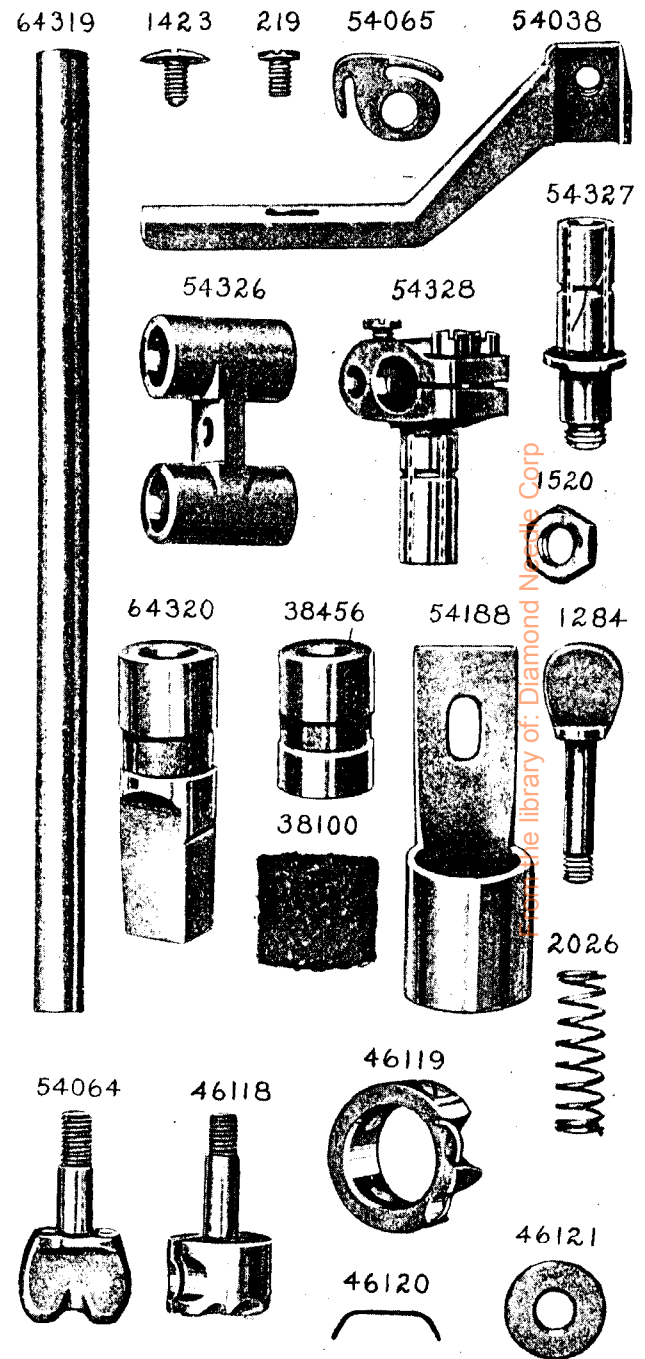


PLATE 8991—FULL SIZE



Copyright © 1950 by the American Society of Mechanical Engineers
 Library of: Diamond Machine Corp

PLATE 8992—FULL SIZE

54246 54071

54204

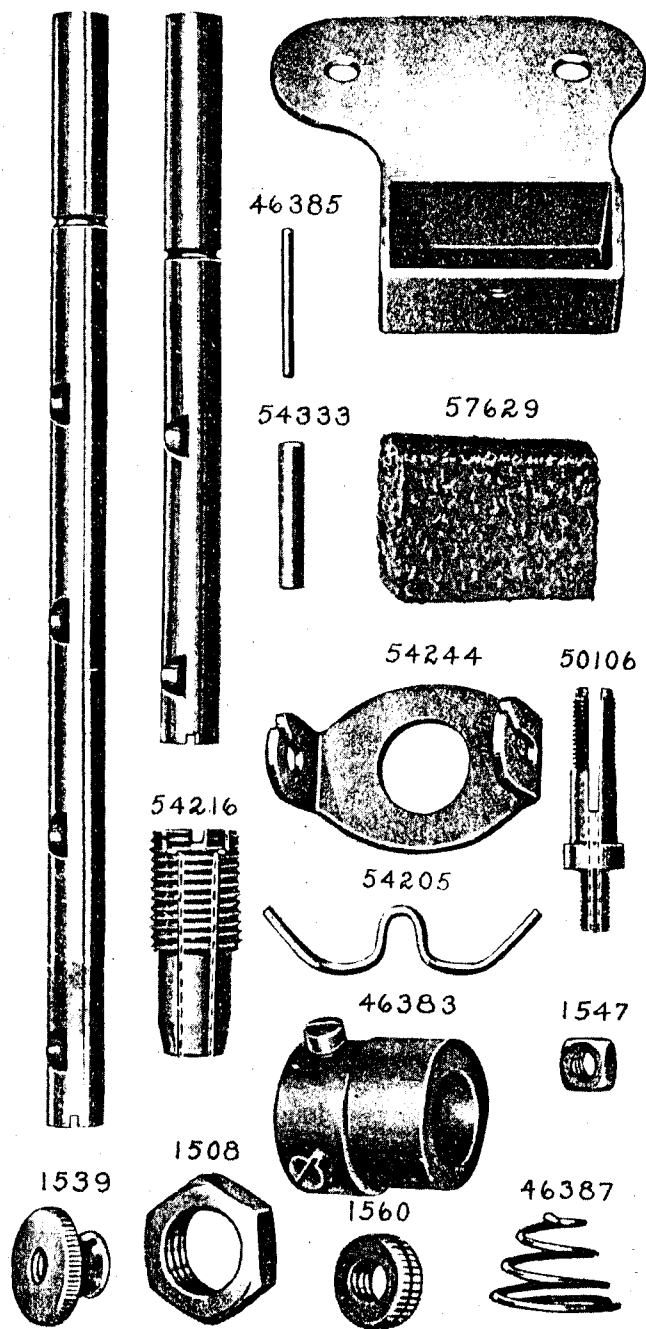


PLATE 8993—FULL SIZE

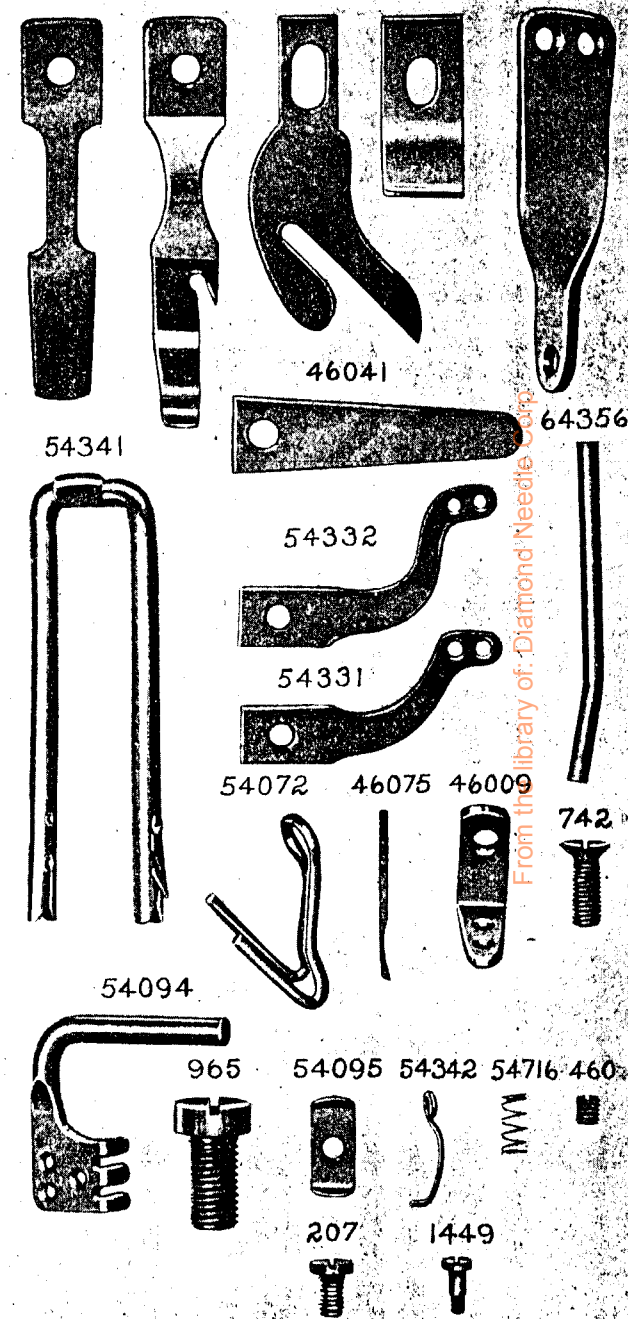
38210

38211

38482

46247

53225



From the library of: Diamond Needle Corp.

PLATE 8994—FULL SIZE

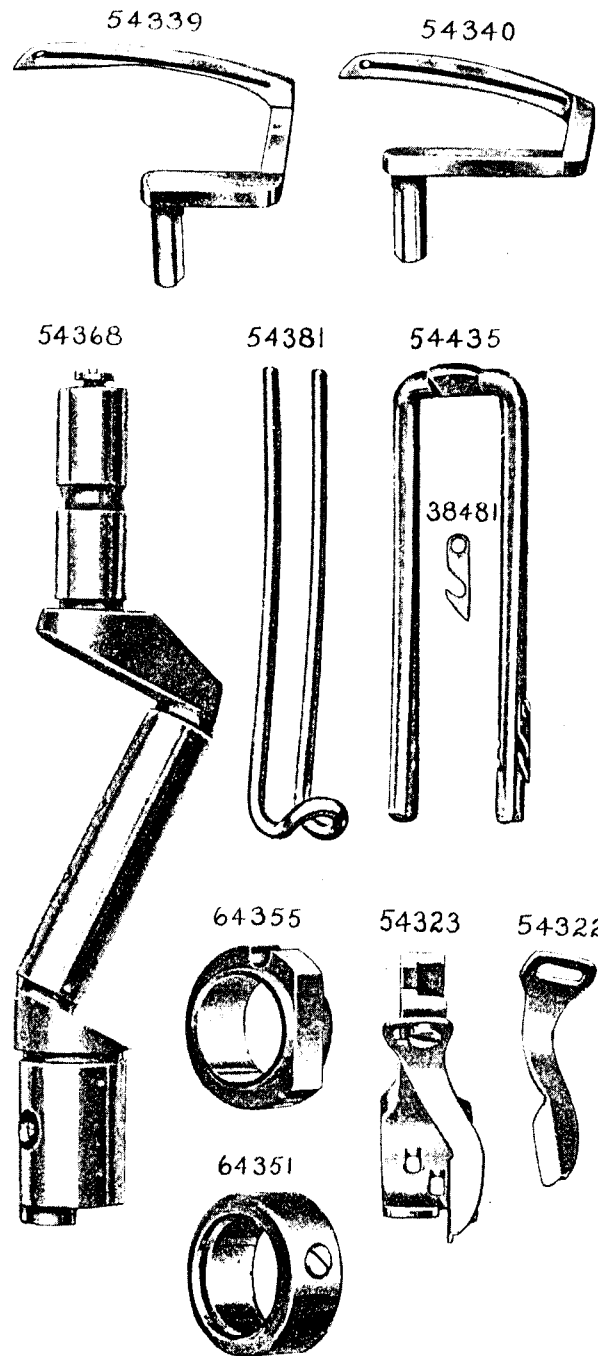


PLATE 8995—FULL SIZE

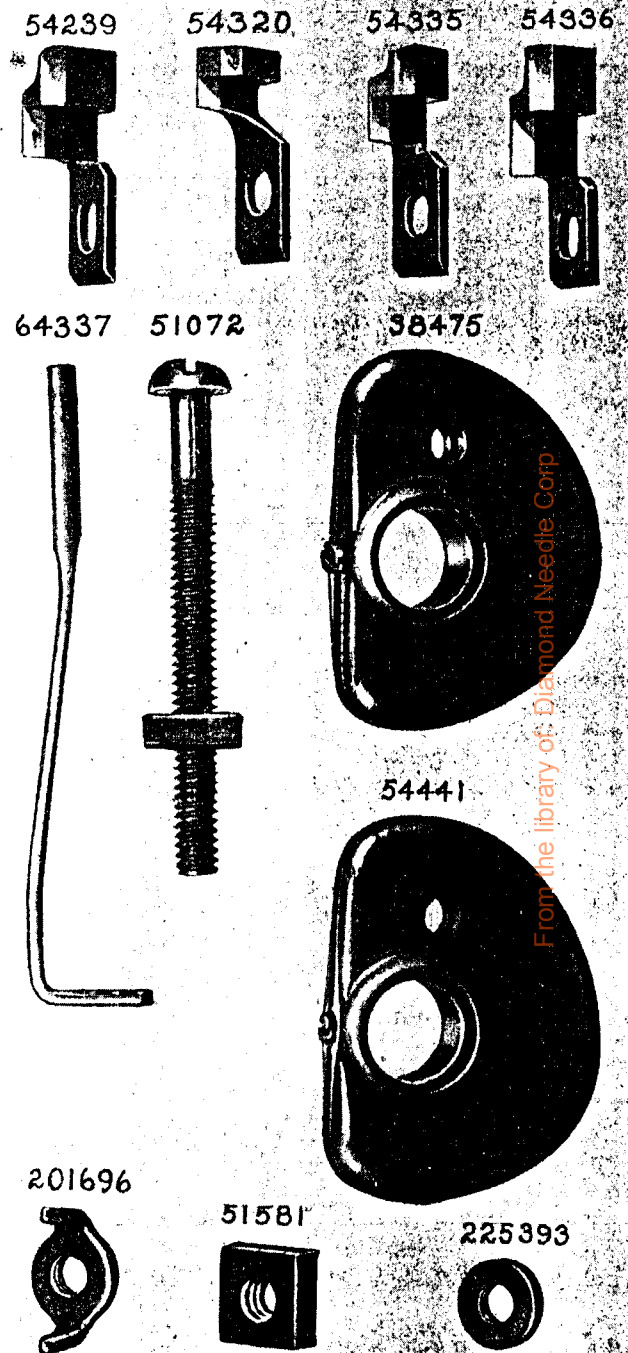


PLATE 8996—ONE-HALF SIZE

64362 54245 54070 49123

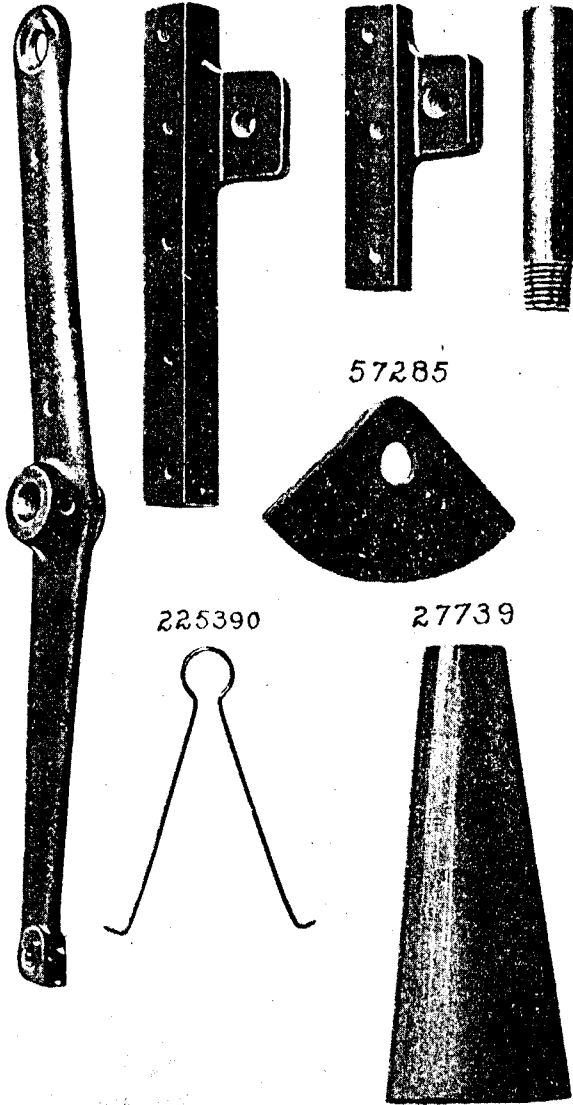


PLATE 8997—ONE-SIXTH SIZE

